



LIP-9070

---

## User Guide

Please read this manual carefully before operating Phone.  
Retain it for future reference

iPECS is an Ericsson-LG Brand



## What is new in this release?

Issue	Date	Change of Contents
1.0	March, 2013	Initial Release

### **Copyright© 2013 Ericsson-LG Co., Ltd. All Rights Reserved**

*This material is copyrighted by Ericsson-LG Co., Ltd. Any unauthorized reproductions, use or disclosure of this material, or any part thereof, is strictly prohibited and is a violation of Copyright Laws. Ericsson-LG reserves the right to make changes in specifications at any time without notice. The information furnished by Ericsson-LG in this material is believed to be accurate and reliable, but is not warranted to be true in all cases.*

---

## Regulatory and Safety Notices

### European Union Declarations of Conformity

Ericsson-LG Co., Ltd. declare that the equipment specified in this document bearing the "CE" mark conforms to the European Union Radio and Telecommunications Terminal Equipment Directive(R&TTE 1999/5/EC), including the Electromagnetic Compatibility Directive(2004/108/EC) and Low Voltage Directive(2006/95/EC).

Copies of these Declarations of Conformity (DoCs) can be obtained by contacting your local sales representative.

### [USA/CSA]

#### FCC/IC Interference Statement

This equipment has been tested and found to comply with the limits for a Class B digital device, pursuant to part 15 of the FCC Rules.

These limits are designed to provide reasonable protection against harmful interference in a residential installation.

This equipment generates, uses and can radiate radio frequency energy and, if not installed and used in accordance with the instructions, may cause harmful interference to radio communications. However, there is no guarantee that interference will not occur in a particular installation. If this equipment does cause harmful interference to radio or television reception, which can be determined by turning the equipment off and on, the user is encouraged to try to correct the interference by one or more of the following measures:

- Reorient or relocate the receiving antenna.
- Increase the separation between the equipment and receiver.
- Connect the equipment into an outlet on a circuit different from that to which the receiver is connected.
- Consult the dealer or an experienced radio/TV technician for help.

This device complies with part 15 /RSS-GEN of the FCC/IC rules. Operation is subject to the following two conditions:

(1)This device may not cause harmful interference; and (2) This device must accept any interference received, including interference that may cause undesired operation.

This Class B digital apparatus complies with Canadian ICES-003.

Cet appareil numérique de la classe B est conforme à la norme NMB-003 du Canada.

The use of this device in a system operating either partially or completely outdoors may require the user to obtain a license for the system according to the Canadian regulations.

---

**CAUTION** : Any changes or modifications in construction of this device which are not expressly approved by the party responsible for compliance could void the user's authority to operate the equipment.

## Regulatory Information / Disclaimers

"Privacy of communications may not be ensured when using this telephone".

Any changes or modifications made to this device that are not expressly approved by the manufacturer may void the user's authority to operate the equipment.

The Manufacturer is not responsible for any radio or television interference caused by unauthorized modification of this device, or the substitution or attachment of connecting cables and equipment other than those specified by the manufacturer. It is the responsibility for the user to correct any interference caused by such unauthorized modification, substitution or attachment.

The manufacturer and its authorized resellers or distributors will assume no liability for any damage or violation of government regulations arising from failure to comply with these guideline.

The device is certified to the requirements of RSS-210 for 2.4GHz spread spectrum devices.

The use of this device in a system operating either partially or completely outdoors may require the user to obtain a license for the system according to the Canadian regulations. For further information contact your Local Industry Canada office.

## Important Safety Instructions

When using your telephone equipment, basic safety precautions should always be followed to reduce the risk of product damage, fire, electric shock and personal injury, including the following:

- Please read and understand all instructions.
  - Follow all warnings and instructions marked on the product.
  - To prevent the risk of fire, electric shock or energy hazard, do not use this product near water or expose this product to rain or any type of moisture at any time.
  - Do not place this product on an unstable table, stand, or card table; the product may fall, causing serious damage to the product or serious injury to those nearby.
  - This product should be operated only from the type of power source indicated on the product label. If you are not sure of the type of power supply at your location, consult your dealer or local power company.
  - Do not allow anything to rest on the wiring to the product. Do not locate this product where the cords or wiring could be abused by people walking on it.
  - Do not overload wall outlets and extension cords as this can result in the risk of fire or electric shock.
  - To reduce the risk of electric shock, do not disassemble this product. Instead, take it to a qualified person when service or repair work is required. Opening or removing covers may expose you to dangerous voltages or other risk. Incorrect reassemble can cause electric shock when the appliance is subsequently used.
  - Unplug this product from the wall outlet and refer servicing to qualified service personnel under the following conditions:
-

- When the power supply cord, plug or other wiring to the product is damaged or frayed.
  - If liquid has been spilled into the product.
  - If the product has been exposed to rain or water.
  - If the product does not operate normally by following the operating instructions.
  - If the product has been dropped.
  - If the product exhibits a distinct change in performance.
  - If a failure occurs which exposes any internal parts, disconnect the power supply cord and wiring immediately and contact your system administrator.
- Keep the product away from heating appliances and electrical noise generating devices such as florescent lamps, motors and televisions. These noise sources can interfere with the performance of the **iPECS** system.
  - This product should be kept free of dust, moisture, high temperature (more than 40 degrees) and vibration, and should not be exposed to direct sunlight.
  - Avoid using the telephone during an electrical storm; there is a remote risk of electric shock from lightning.
  - In the event of a gas leak, do not use the telephone near the leak.
  - Never attempt to insert wires, pins, etc. into the product. If the product does not operate properly, the equipment should be repaired by an authorized Ericsson-LG service center.
  - Do not use benzene, paint thinner, or an abrasive powder to clean the product. Wipe it with a soft cloth only.

## Disposal of Old Appliance

When the displayed symbol (crossed-out wheeled bin) is adhered to a product, it designates the product is covered by the European Directive 2012/19/EU.



All electric and electronic products should be disposed of only in special collection facilities appointed by government or local/municipal authorities.

The correct disposal of your old appliance will help prevent potential negative consequences for the environment and human health.

For more detailed information about disposal of your old appliances, please contact your city office, waste disposal service or the place of product purchase.

## Table of Contents

1	Introduction.....	1
2	Installation .....	2
2.1	Overview.....	2
2.2	Removing the Cord Cover.....	3
2.3	Mounting the Phone and Pedestal .....	3
2.4	Network Connections .....	3
2.5	Optional AC/DC Adapter Connections.....	4
2.6	Connect the Handset and Optional Headset .....	4
2.7	Replace the Cord Cover.....	4
2.8	Power up and Setup Wizard.....	5
2.8.1	Language Selection .....	5
2.8.2	Protocol Selection .....	5
2.9	Registration .....	6
2.10	Mounting and Dismounting an SD card .....	7
3	Basics Operation .....	8
3.1	Incoming Calls .....	8
3.2	Outgoing Calls .....	8
3.3	Holding Calls .....	9
3.4	Transferring a Call .....	9
3.5	Conference .....	9
4	Mini-Tab Phone Display Basics.....	10
4.1	Basic User Gestures .....	10
4.2	Mini-Tab Function Buttons .....	11

---

4.3	Mini-Tab Menus .....	11
4.3.1	Screen Option Menus .....	11
4.3.2	Touch and Hold Context Menus .....	11
4.3.3	Dialogs and Popups .....	12
4.4	Launcher Screens .....	12
4.5	Home Screen.....	12
4.6	Application Dock.....	12
4.6.1	Managing the App Dock.....	13
4.6.1.1	Adding Icons to App Dock,.....	13
4.6.1.2	Deleting Icons from the Apps Dock.....	13
<b>4.7</b>	<b>Notification And Status Bar.....</b>	<b>14</b>
4.8	Customize the Launcher Screens .....	16
4.8.1	Adding Apps and Widget.....	16
4.8.2	Reposition or Delete a Screen Item .....	16
4.9	Handling Widgets .....	17
<b>5</b>	<b>iPECS Phone.....</b>	<b>18</b>
<b>5.1</b>	<b>Speed.....</b>	<b>19</b>
5.1.1	Using Auto dialing .....	19
5.1.2	Setting up a Station Speed Dial .....	20
<b>5.2</b>	<b>Call Back Message Wait .....</b>	<b>20</b>
<b>5.3</b>	<b>Flex Buttons .....</b>	<b>21</b>
5.4	Video Calling .....	21
5.5	iPECS Phone Call Settings .....	22
5.5.1	Preferences.....	23
5.5.2	Flex Button Labels .....	23
5.5.3	Phone Management.....	24
5.5.4	Ringtone Sounds.....	24
5.5.5	System Configuration.....	24
5.5.6	Reboot .....	25

---

---

<b>6</b>	<b>Working with Contacts</b>	<b>26</b>
6.1	Searching the Contacts	26
6.2	Communicating with Contacts	26
6.3	Managing the Contact Database	27
6.3.1	Adding a Contact	27
6.3.1.1	CO Access Code	28
6.3.2	Display Options	28
6.3.3	Import and Export Contacts	29
6.4	Managing a Contact Record	30
6.4.1	Edit Contact Information	30
6.4.2	Deleting a Contact	30
6.4.3	Joining Contact records	30
6.5	Favorites	31
6.6	Miscellaneous Contact Options	31
6.6.1	Contact's Default Number	31
6.6.2	Send to Voice Mail	31
6.6.3	Contact Ringtone	31
6.6.4	Share a Contact	32
<b>7</b>	<b>Call Log</b>	<b>33</b>
7.1	Viewing the Call Logs	33
7.2	Using the Call Logs	33
<b>8</b>	<b>Using SMS (Short Message Service)</b>	<b>35</b>
8.1	Send a Message	35
8.1.1	Options Menu	36
8.2	Receive a Message	36
8.3	Message Options	37
8.4	Messaging Screen Options Menu	37
8.4.1	Deleting a Message Thread	38

---



---

8.4.2 Messaging Settings.....	38
<b>9 Appointment/Event Calendar .....</b>	<b>39</b>
9.1 Viewing Schedule details .....	40
9.2 Managing Schedules .....	40
9.2.1 Add an Event Schedule.....	40
9.2.2 Edit an Event Schedule.....	40
9.2.3 Delete an Event Schedule.....	41
9.3 Responding to a Reminder.....	41
<b>10 General Purpose Apps.....</b>	<b>42</b>
10.1 Setting the Alarm Clock.....	42
10.2 Using the Calculator .....	43
10.3 Handling Pictures and Videos .....	43
10.3.1 Taking Pictures .....	44
10.3.2 Recording Videos.....	44
10.3.3 Picture and Video Controls .....	45
10.3.4 Review Pictures and Videos.....	46
10.3.5 Using the Gallery and Albums.....	46
10.3.5.1 Viewing a Slide show.....	47
10.3.5.2 Selecting Multiple Pictures.....	47
10.3.5.3 Viewing Pictures .....	47
10.3.5.4 Picture Gallery Tools .....	48
10.3.5.5 Viewing Videos .....	49
10.4 Playing Music .....	49
10.4.1 Playing Songs .....	50
10.4.2 Playing a Party-Shuffle.....	50
10.4.3 Play songs from a Playlist .....	50
10.4.4 Managing Playlists .....	51
10.4.4.1 Create a Playlist .....	51

---

---

10.4.4.2 Add Songs to a Playlist.....	51
10.4.4.3 Rename a Playlist.....	52
10.4.4.4 Delete a Playlist.....	52
10.4.4.5 Delete Song from Playlist.....	52
10.4.5 Delete Songs from SD Card.....	52
10.4.6 Use as Ringtone.....	52
<b>11 Managing Bluetooth .....</b>	<b>53</b>
11.1 Bluetooth Headset .....	53
11.2 Bluetooth Handsfree .....	53
11.2.1 Bluetooth HF Call Waiting .....	54
11.2.2 Outgoing HFP call .....	55
11.2.3 Audio Transfer.....	55
11.2.4 Bluetooth HF Audio Priority .....	55
<b>12 Settings.....</b>	<b>56</b>
12.1 Network and Bluetooth .....	56
12.1.1 Network (Ethernet) Configuration.....	57
12.1.1.1 OpenVPN .....	57
12.1.1.2 LLDP Setting .....	58
12.1.1.3 802.1x Setting.....	58
12.1.2 Bluetooth settings.....	58
12.2 Sound .....	59
12.3 Display .....	59
12.4 Applications .....	60
12.5 Privacy .....	60
12.6 Storage .....	60
12.6.1 SD Card .....	61
12.7 Language & Keyboard.....	61
12.8 NTP settings .....	61

---

12.9 About phone .....	62
12.9.1 System Updates.....	62
Appendix A Station User Programming.....	63
Appendix B Web Admin .....	66
Appendix C Touch screen calibration.....	75

---

## 1 Introduction

The LIP-9070 is an advanced business communications terminal for use with **iPECS** platforms. The phone employs a Mini-tab running the Android OS as a display and user control interface. The **iPECS** Phone application is permanently installed and provides the user with access to all the features and functions of the **iPECS** plus the interaction with other communications aware apps with a truly intuitive user touch interface. In addition, the Mini-tab is loaded with apps for Contacts, Calendar, Video, etc. to improve productivity and ease of use.



## 2 Installation

### 2.1 Overview

The LIP-9070 is shipped with the LIP-9070 phone, handset, pedestal, 6-ft Cat 5 cable terminated in RJ-45 connectors and the Quick Guide. An optional AC/DC adapter is available for use when the network connection does not support IEEE 802.3af class 3 PoE (Power over Ethernet). The figures below present line drawings of the front and rear of the LIP-9070 identifying major elements of the user interface and external connections.

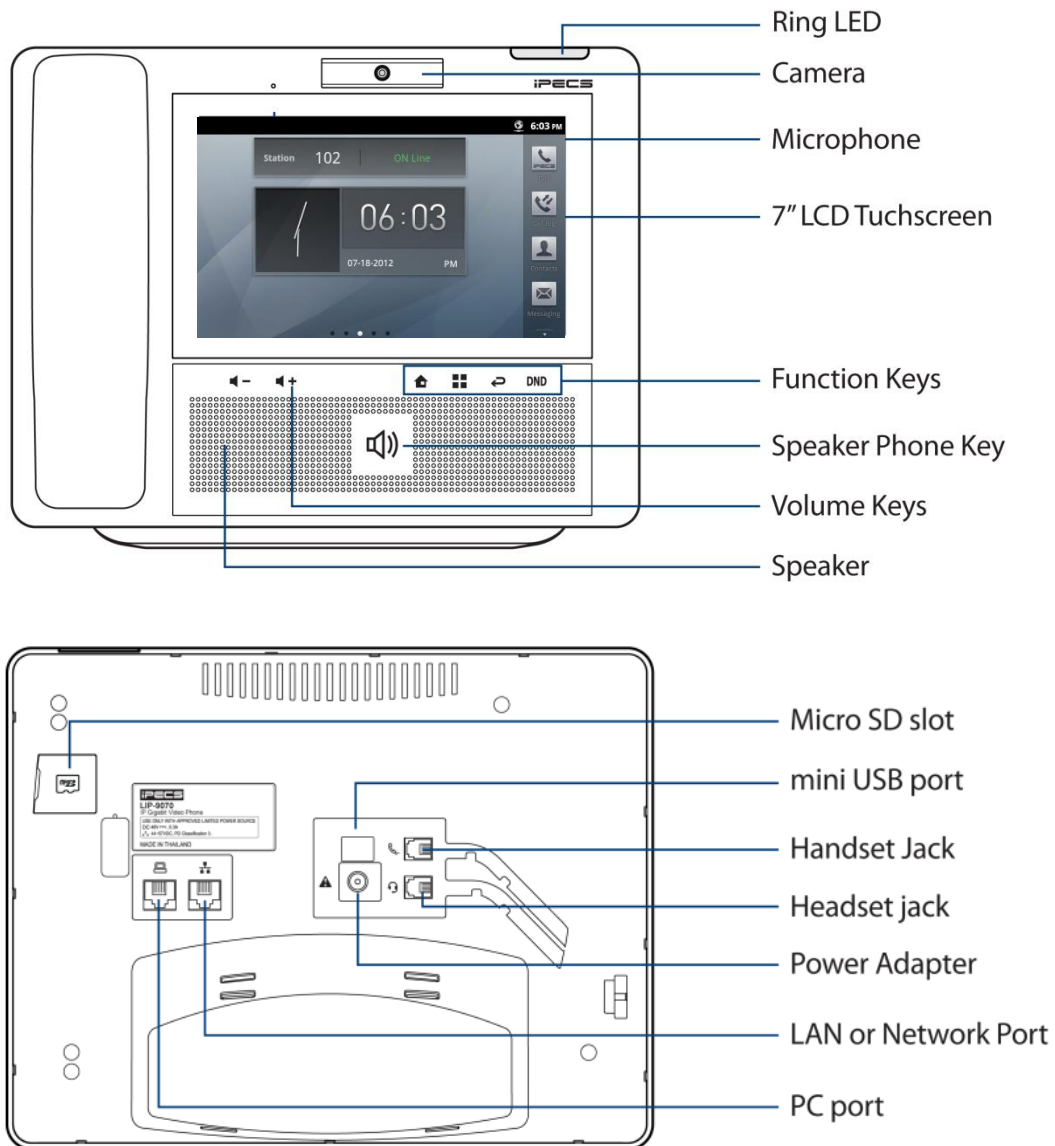

## 2.2 Removing the Cord Cover

Before proceeding with the installation, the Line Cord Cover, which protects the LAN cabling, should be removed from the pedestal. To remove the cover, lift the cover plate as shown.

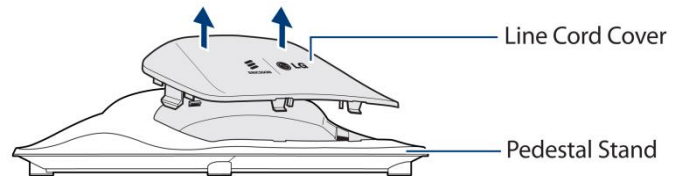

## 2.3 Mounting the Phone and Pedestal

The phone attaches to the pedestal in either a 40° or 60° angle and should be adjusted at installation for the preferred viewing angle. To mount the phone on the pedestal,

1. Remove the wiring cover as in section 2.2.
2. Select which side of the pedestal to use, 40° or 60°, and align the grooves in the base of the phone with the appropriate hooks on the pedestal.
3. Pull down at the top of the phone to engage the hooks of the pedestal with the slots in the phone base.

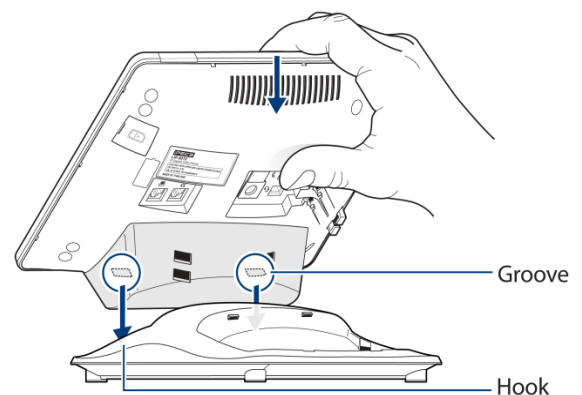

## 2.4 Network Connections

The LIP-9070 has two RJ-45 Ethernet LAN jacks on the bottom of the phone. One of the jacks is the interface to a local IEEE 10/100/1000 Base-T Network port. The other jack is a 10/100/1000 Base-T port for connection to a PC.

The network interface port jack is wired as a standard MDI connection and the PC port is wired as an MDIX connection. This wiring structure allows use of straight-through cables.

The LIP-9070 network and PC ports support Auto negotiation for MDI/MDIX, speed and duplex (full or half). The MDI and MDIX wiring for the LIP-9070 network and PC connections are in accordance with TIA/EIA standard 568.

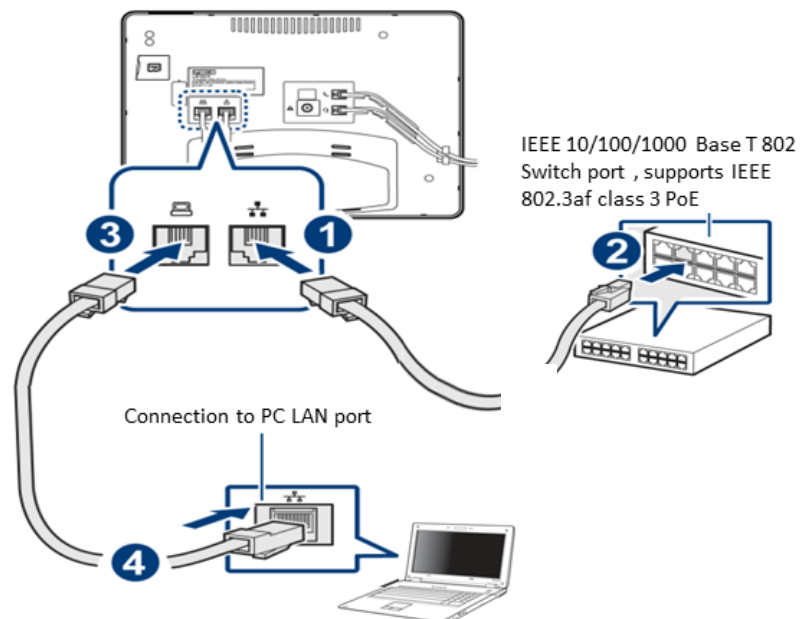

## 2.5 Optional AC/DC Adapter Connections

The optional AC/DC adapter is used when the network connection is not PoE compatible. In this case, the AC/DC adapter converts the normal AC power input to the 48 VDC at 0.3 amps required by the LIP-9070. The adapter is plugged into a standard AC wall outlet and the DC connector is inserted in the DC jack located on the bottom of the phone.

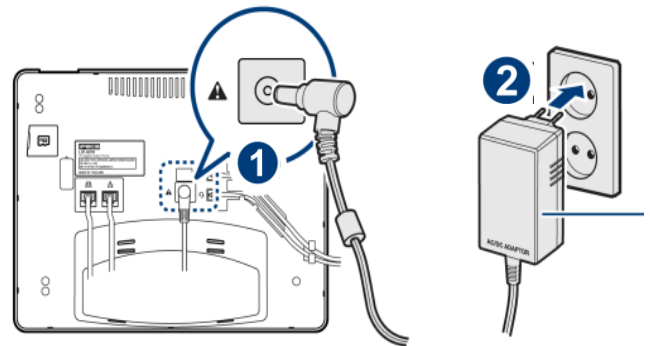

## 2.6 Connect the Handset and Optional Headset

The handset and headset connectors are located slightly to the right center of the phone. The handset coil cord RJ-9 is plugged into the upper RJ-9 jack of the phone and handset. The lower RJ-9 jack can be used for a wired headset. When using a wired headset, the Speakerphone button activates audio to the headset.

After connecting the handset coil cord and the headset cord, firmly place the cords in the respective wiring channel to protect the wiring.

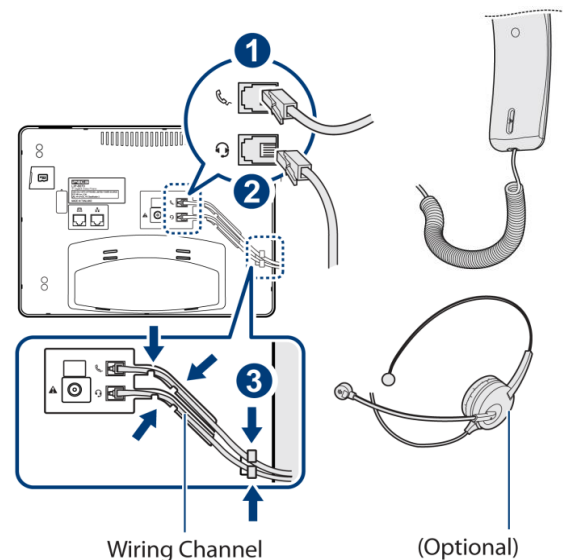

## 2.7 Replace the Cord Cover

After completing the wiring and mounting of the phone, the Line Cord cover should be replaced to protect the Line cords and the AC/DC adapter wiring. The cover has tabs on the bottom that fit into slots in the pedestal. To replace the cover, align the tabs with the slots making sure the wiring is located beneath the cover but not in the path of the tabs. Push down firmly on the cover to fully engage the tabs and slots.

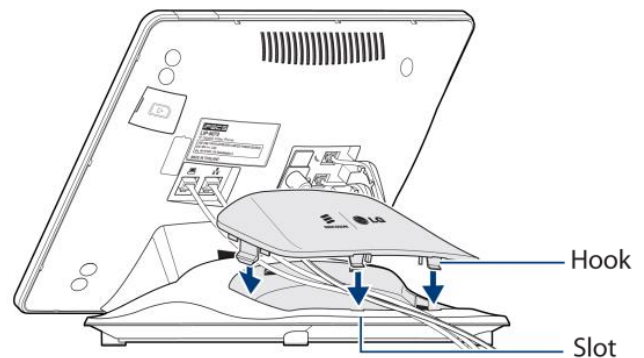

## 2.8 Power up and Setup Wizard

---

When connected to power, the phone will perform Setup Wizard for language selection.

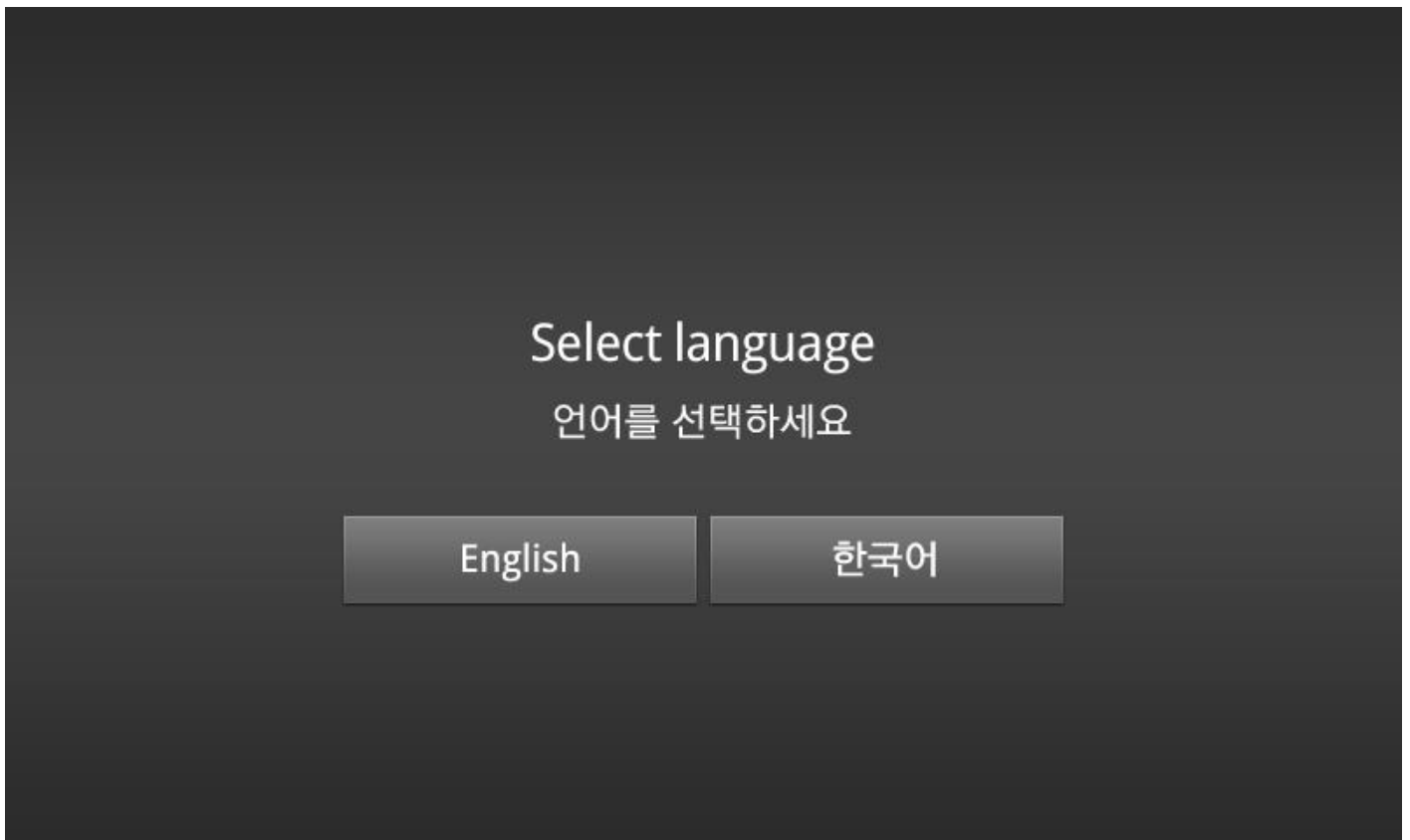

### 2.8.1 Language Selection

---

When connected to power, the phone will perform language selection. User can choose Language to be used for the Phone. Base on this selection, the software keyboard and IME for phone will be changed.

### 2.8.2 Protocol Selection

---

After select language it could be guided to select call protocol. To use LIP-9070 as iPECS iPKTS phone, choose iPKTS protocol from below selection screen. Then will restart automatically.



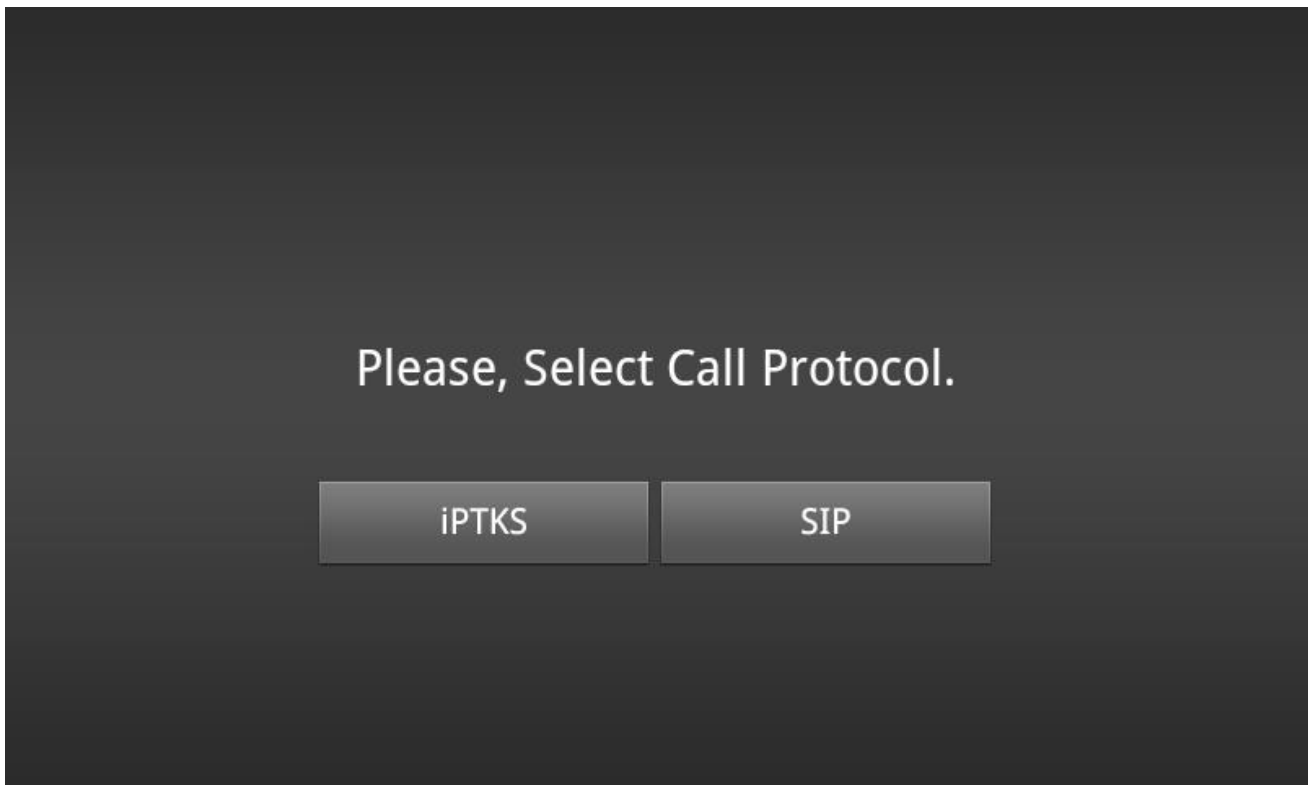

## 2.9 Registration

When connected to power and the network, the phone will perform its power-up routine and then attempt to locate and register with the **iPECS** system. During the process the display will indicate status including 'Searching for MFIM', which is the **iPECS** call server. In a default configuration, **iPECS** will permit registration of the phone, and will assign a station number and other characteristics to the phone. Once complete the phone is fully operational and displays the Home screen with the Station Number and status (On Line) shown above the clock.

If the **iPECS** network settings have been changed or the phone is installed in a remote location, the phone will not be able to complete registration. The phone screen will display a No Acknowledgement or other fault message. In this case, assistance of the **iPECS** administrator may be required. **iPECS** may require configuration to allow registration of the LIP-9070. In addition, the IP settings of



the phone, section 12.1.1, and the System Configuration data, section 5.5.5, may require modification with the assistance of the *iPECS* administrator.

## 2.10 Mounting and Dismounting an SD card

An SD card can be installed in the SD card slot on the right side of the LIP-9070. The SD card expands the memory of the LIP-9070, stores pictures, videos and music. Note once an SD Card is inserted in the slot, it must be 'unmounted' properly to safely remove.

To mount an SD card:

1. Uncover the SD slot located on the left side of the phone.
2. Position the SD card with the gold strips facing down.
3. Slide the card into place until it is fully inserted and locked in place. The phone will inspect the card to prepare it for use.

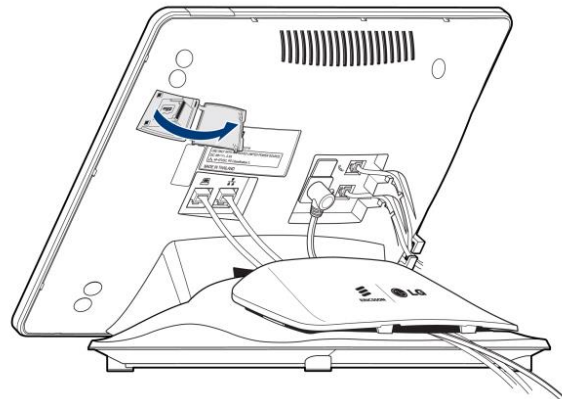

To safely remove the SD card from the phone, the card must first be unmounted. To remove the SD card,

1. Select 'Unmount SD card' from the System Settings Storage menu as shown in section 12.6.1. The  icon indicates that it is safe to remove the card.
2. Open the SD card slot cover.
3. Gently push the card in to release the card lock.
4. Carefully pull the card from the slot.

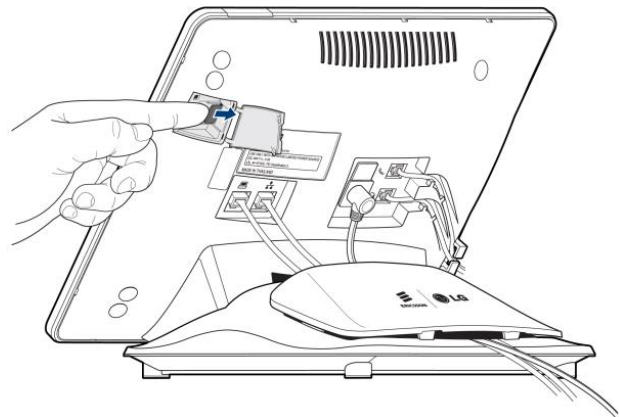

### Note

- Do not remove the SD card during a file transfer or while files are being accessed or transferred. If the card is removed in such circumstances, loss or damage to data may result.

### 3 Basics Operation

The *iPECS* Phone application is fully available once the LIP-9070 completes registration with the *iPECS* host as outlined in section 2.8. The *iPECS* Call icon in the Apps Dock opens the *iPECS* Phone app where calls can be managed. Details for using the *iPECS* Phone window beyond the basics are covered in section 6.

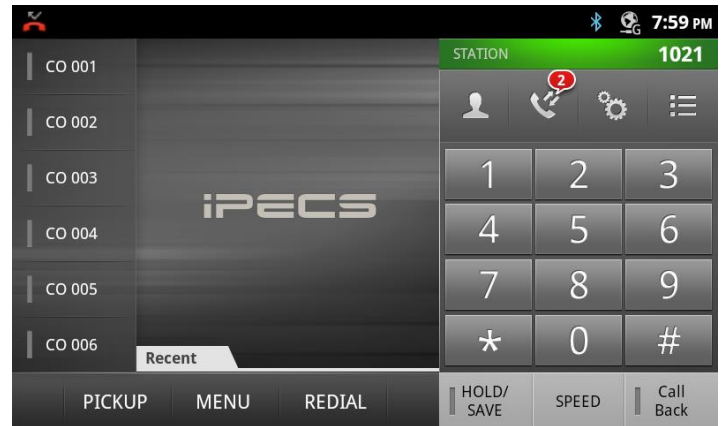

#### 3.1 Incoming Calls

When a call is received, the Call screen displays the Caller Id for the call and the phone rings. If the Caller Id matches the number for a contact, the contact icon and name of the Contact are shown.

To answer the call, lift the handset or press the speakerphone button.

**Note**

- The DND button is available to activate One-time DND. For details refer to the *iPECS* Phone user guide.

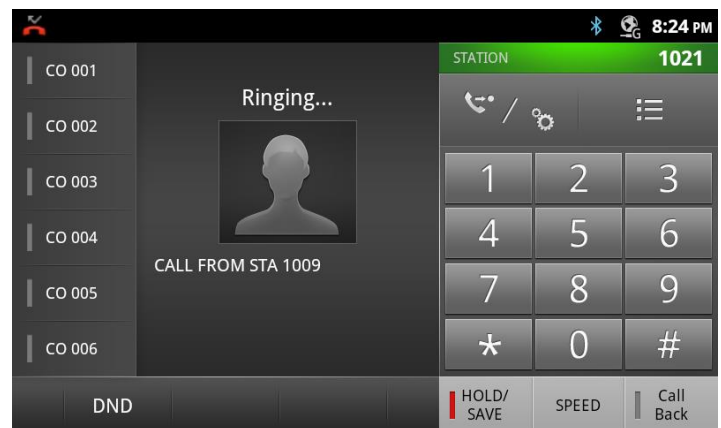

#### 3.2 Outgoing Calls

The LIP-9070 employs a “live dial pad” meaning that you need not lift the handset or press the Speakerphone button to start a call. To place a call, dial the desired number. This will activate the speakerphone, send the digits to the *iPECS* host and show the dialing screen. When sufficient digits have been dialed, the *iPECS* host routes the call.

Outgoing calls can also be placed from the Contacts and Logs as well as Speed dial refer to sections 6, 7 and 5.1.1, respectively.

**Note**

- The user may go off-hook (press the Speakerphone button or lift the handset) before dialing. In this case, the phone receives dial tone from the *iPECS* host.

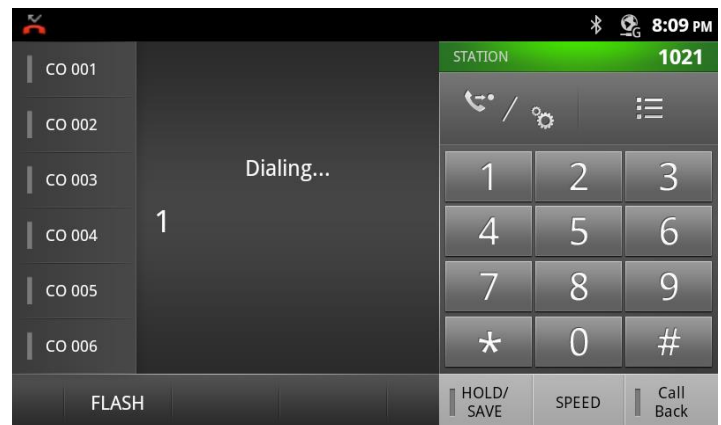

### 3.3 Holding Calls

You can place a call in a waiting state where the caller is connected to the Music on Hold source of the *iPECS* system, freeing you for other activities. The call will remain on hold for the hold recall time then the user is recalled.

To place a call on Hold, touch the Hold/Save button, the button will light to indicate the held call.

### 3.4 Transferring a Call

Once connected to a call the Transfer icon, as highlighted on the right, is used to send the call to another destination. After touching the Transfer icon, dial the station to receive the call. The call transfer can be unannounced (simply hang-up) or announced (after the receiving party answers, announce the call and hang-up).

#### Note

- A transfer can be accomplished by touching a Flex button assigned as a DSS for another station in the *iPECS* host.

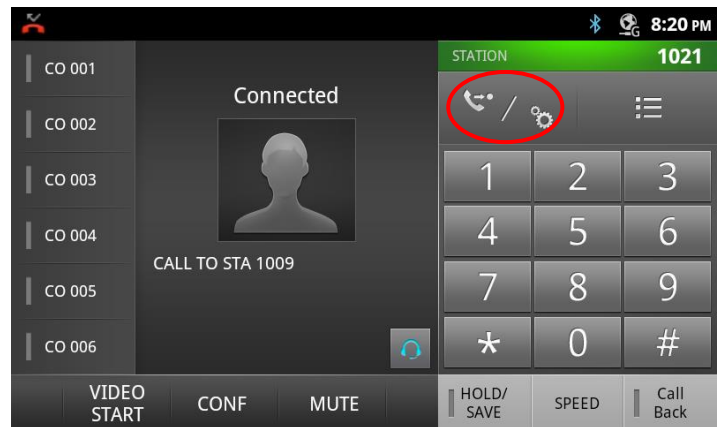

### 3.5 Conference

An active call can be joined with another call to establish a conference. If the *iPECS* host is equipped with a Conference bridge, up to 32 parties can be included in a conference.

To conference calls,

1. Place/receive first call as usual.
2. Touch the CONF soft button,
3. Place next call and press the CONF soft button.
4. Repeat step 3 for additional parties
5. Press the CONF soft button again to connect all parties.

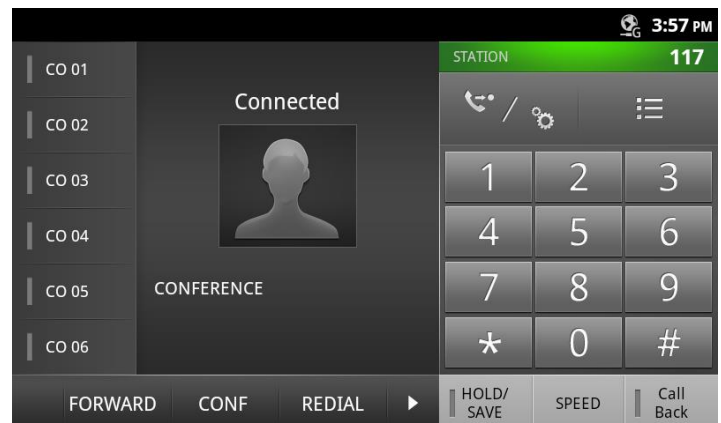

#### Note

- The LIP-9070 supports a 3-party conference without the need of a Conference bridge. If conferences with more than three parties are required, the *iPECS* host must be equipped with a conferencing bridge such as the MCIM.

## 4 Mini-Tab Phone Display Basics

The LIP-9070 phone employs a Mini-tab running the Android OS as the phone display and the main user input device. The Mini-tab is equipped with several apps and widgets which are discussed in separate sections of this manual as below.

- iPECS* Phone, section 5
- Contacts, section 6
- Call Logs, section 7
- SMS, section 8
- Appointment Calendar, section 9
- Alarm Clock, section 10.1
- Camera, section 10.2
- Gallery, section 10.2
- Music, section 10.3
- Settings, section 12

In addition to the major applications above, several widgets are installed in the LIP-9070. Widgets are small applications that display on a Launcher screen and are self-contained, that is no additional screens are needed by the widget. Widgets may open a related application but are primarily intended to provide information such as the time, date, or status of music playing. Widgets settings are discussed in section 4.8 and 4.9, and include:

- Clock widget
- Play Music widget
- Calendar widget
- iPECS* Station (Call Info) widget

### 4.1 Basic User Gestures

The Mini-tab uses a touchscreen as the user interface. There are several finger gestures supported by the Mini-tab for user interaction.

- *Touch or Tap*: To select items such as application icons, to press onscreen buttons, or to type using the onscreen keyboard, touch or tap the item.
- *Touch and Hold*: To open the Context menu for an item, touch and maintain contact with the screen until an action occurs.
- *Swipe or Flick*: To move from one Launcher screen to another or view the next or previous picture, touch the screen and quickly move to the finger across the surface of the screen.

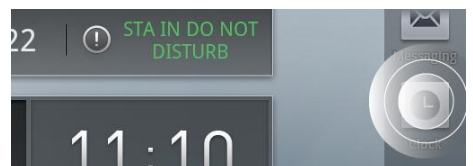
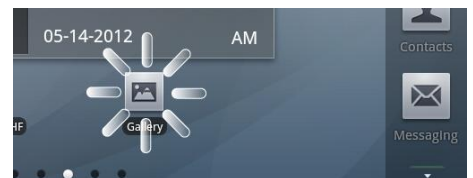

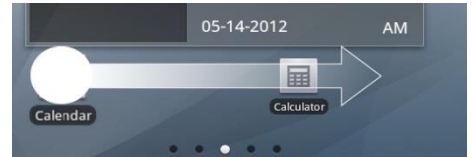

- *Drag and drop:* To move an app or icon on the Launcher screens, touch and hold momentarily then, while maintaining contact with the screen, drag the item on the Launcher screen.
- *Pinch:* To zoom in and out on a picture, touch the screen with the thumb and forefinger and bring together or separate the fingers to shrink or enlarge a picture.



## 4.2 Mini-Tab Function Buttons

The LIP-9070 has three function buttons related to the Android OS as shown to the right. The function buttons are:

- *Home:*  return to the Home screen.
- *Option*  *menu:* menu associated with the viewed screen. The menu displays in the bottom of the screen.
- *Back* : return to the previous screen. If a keyboard or numeric keypad is shown in the screen, touching the Back button closes the keyboard or keypad.



## 4.3 Mini-Tab Menus

The Mini-tab has several menus structured by the Android OS. Three basic menu types are employed the screen Option menu, the touch and hold Context menu and general purpose popup menus.

### 4.3.1 Screen Option Menus

Many screens, including the Launcher screens, have an Options menu that is accessed by touching the Option Menu button. The menu, which is specific to a screen, displays along the bottom of the screen. A 'more' selection is shown if there are more menu items than can be displayed comfortably. The 'more' selection generally displays in a popup list.

### 4.3.2 Touch and Hold Context Menus

The Context menus impact an Individual item or record such as a contact, scheduled event, or song. These menus display in a popup in response to the 'Touch and Hold' gesture.



### 4.3.3 Dialogs and Popups

Dialog boxes are employed when a user entry is required such as a contact name. Popups are used to inform the user of potential issues or warning messages such as 'Please insert SD card' or 'Bluetooth not connected'.

## 4.4 Launcher Screens

The Launcher is divided into five (5) screens where shortcut icons and widgets can be located. Selecting an application icon from one of the Launcher screens opens the application. The Launcher Home screen displays upon power-up. Other Launcher screens can be viewed employing the flick gesture. Each Launcher screen can be customized by adding, deleting or moving application icons and widgets.



## 4.5 Home Screen

The Home screen, as with all the Launcher screens, is composed of the Notification and Status bar at the top of the screen, the main display area where application icons and widgets are displayed and the App Dock on the right. The dots on the bottom of the screen indicate the exposed Launcher screen, 1 to 5, with the center screen '3' as the Home screen.

The Home screen as a default includes the **iPECS** Station (CallInfo) widget above the Clock widget in the main display area.

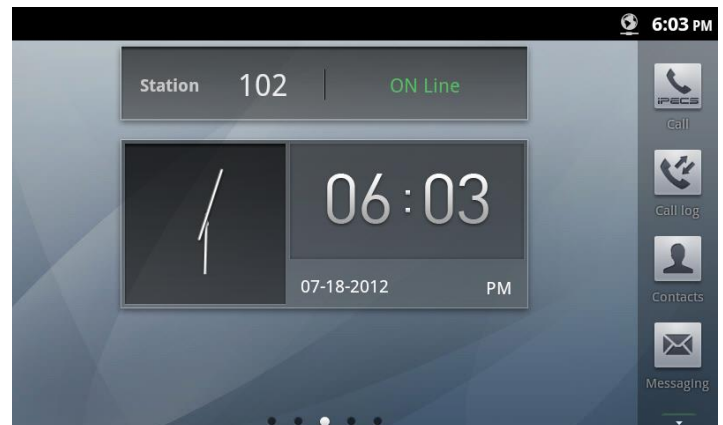

## 4.6 Application Dock

The Application Dock is scrollable and displays up to twenty dock locations for application icons. The scrollable App Dock appears on the right side of all the Launcher screens to permit quicker access to apps than moving across the Launcher screens. The first eight dock locations are available and the first four are fixed with icons for applications in the LIP-9070 including:

 **iPECS** Phone (Call)

 Call Log



Contacts



SMS Message

### 4.6.1 Managing the App Dock

The icon for any installed application can be added to the dock, deleted from the dock or the number of available dock positions changed

#### 4.6.1.1 Adding Icons to App Dock,

To add an application icon to the Apps Dock,

1. Touch and hold an unoccupied dock position shown as the icon

Or

On a Launcher screen touch the Menu button then select the Add button

2. In the Add Context menu, select the desired application icon.
3. Touch OK to add the icon to the dock.

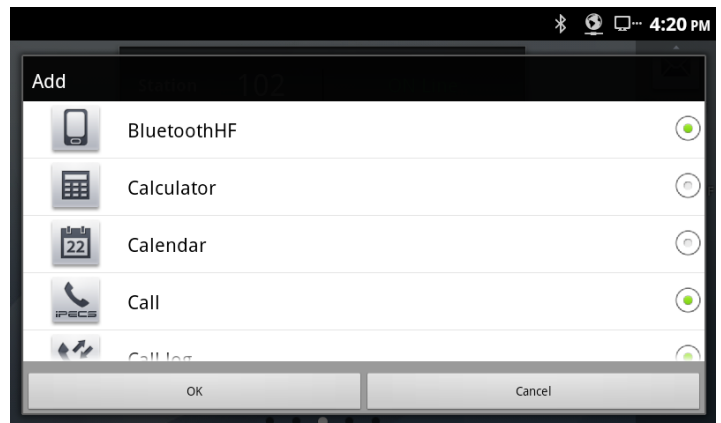

#### 4.6.1.2 Deleting Icons from the Apps Dock

To delete an icon from the dock,

1. In the dock, touch and hold the icon to be deleted.
2. Select 'Delete' from the Dock Setting menu. The icon is removed from the dock but remains on the Launcher screens.

In addition, from the Dock Setting menu the number of available dock positions (maximum 20) and an application icon in the dock can be changed to another application icon.

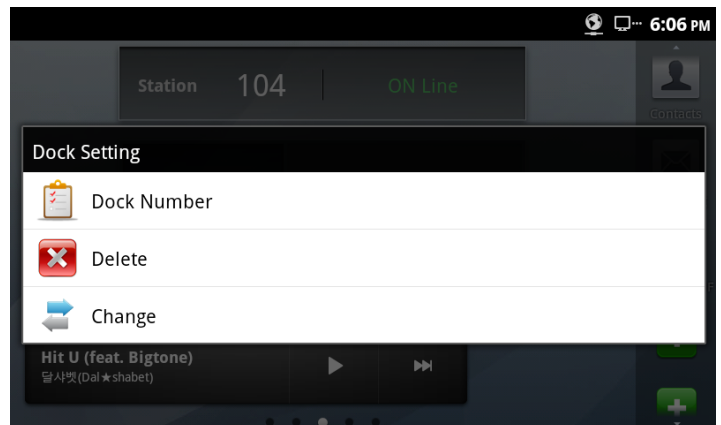



## 4.7 Notification And Status Bar

At the top of the screen is the Notifications and Status bar. Icons to the right indicate the status of connections to the phone, the speaker and alarms. Icons to the left are notifications of new events such as a new SMS and missed call or ongoing events such as call forward or mute. Icons displayed for notifications and states are shown in the chart below.

When a Notification is given a summary is displayed briefly along with the icon. The user can view details of the notification and respond from the Notifications panel. The panel is a scrollable list of all active notifications starting with ongoing events.

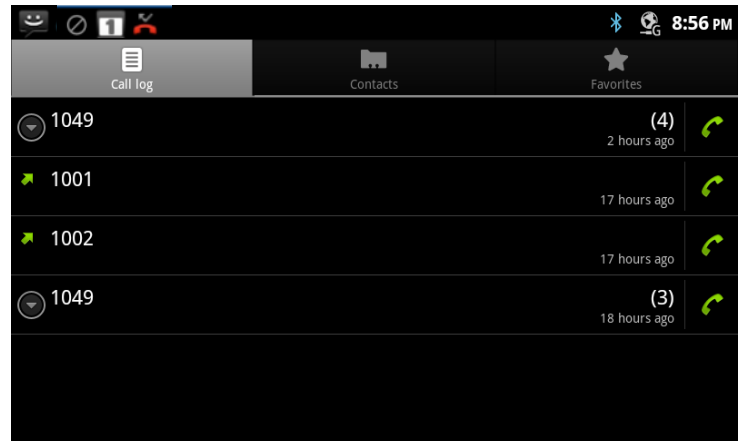

To view the Notification panel,

1. On a Launcher screen touch the Option menu button or  
Touch anywhere along the Notification and Status bar to expose the Notification tab and drag the tab down to open the panel.
2. Scroll the list to review the notifications.
3. Touch a notification to respond.
4. Touch 'Clear' to delete all notifications. This does not delete on-going events such as Call Forward.
5. Touch the Back button to return to the previous screen.

### Status icons:

Icon	Description
	Bluetooth interface active and connected
	Bluetooth active, but not connected
	LAN connected and available
	LAN connected but internet is not available.
	Alarm clock set
	Speaker of speakerphone off. Music and alarms still sound
	Phone is connected to a network using VPN.
	VPN is enabled.
	Phone is connected to a network using LLDP.
	LLDP is enabled.
	VLAN enabled, there is no disabled icon













 802.1x security active

 802.1x security not active.

---

## Notification Icons

---

Icon	Description
	IP Address collision occurs between the nodes.
	SD card removed unexpectedly was not unmounted properly
	SD card being mounted
	SD card unmounted and can be safely removed
	New text (SMS) messages
	Missed calls.
	Calls are being forwarded
	Alarm Snooze active.
	Music is playing.
	DND (Do Not Disturb) active
	Phone microphone muted.
	Reminder of an upcoming event.
	USB port connected

---

## 4.8 Customize the Launcher Screens

Each of the Launcher screens display application icons, widgets and shortcuts to a favorites, playlists, etc. The icons and widgets can be added to or deleted from the Launcher screens or repositioned on the screens. Also, the background wallpaper can be changed.

### 4.8.1 Adding Apps and Widget

To add a shortcut icon or widget to a Launcher screen,

1. Touch and hold an empty spot on the screen or on the desired Launcher screen, touch the Option menu button and touch 'Add'.
2. Select the type of item (Shortcut icon, widget or Wallpapers).
3. In the popup select the specific item to add and touch OK.

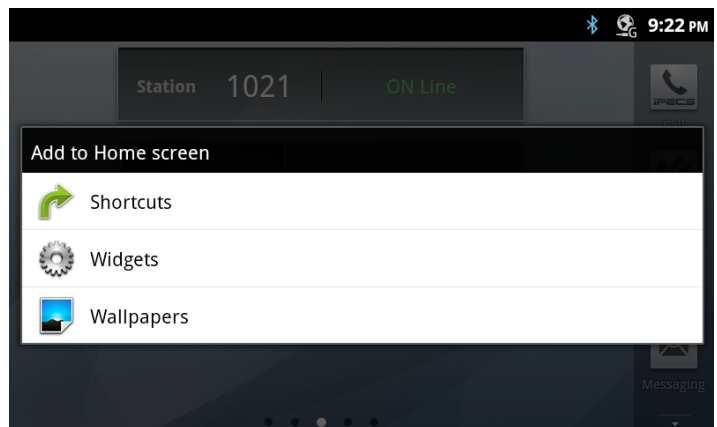

#### Note

- If there is no available space on a Launcher screen, the Add selection in the Options menu will be grey out. To place another widget or icon on the screen an existing icon or widget must be deleted.
- A picture taken with the Camera app can be used as wallpaper as discussed in section 10.3.4.
- Deleting an app or widget from a screen does not delete the application from the LIP-9070.

### 4.8.2 Reposition or Delete a Screen Item

To reposition or delete an icon or widget, use the drag and drop gesture.

1. Touch and hold the application until the Waste-can appears to the right.
2. Drag the icon across the screen, releasing the item at the desired location or on Waste-can to delete.
3. Release the item to reposition or delete it.

#### Note

- When an item is dragged to the Waste-can it will change to a red color.

## 4.9 Handling Widgets

The LIP-9070 is equipped with four (4) widgets; Clock, Calendar, Music and **iPECS** Station. Widgets can be located on any Launcher screen with available space. Touching a widget will open a related application, Clock opens the Alarm Clock, Calendar opens the Appointment Calendar, **iPECS** Station opens the **iPECS** Phone window and Music opens the Music Library.

In addition, using Widgets Setting from the Option menu, the time and date, and the weekday appearance on the clock and calendar widget can be changed to suit the user. Note the date and time are determined by the information from the **iPECS** host.

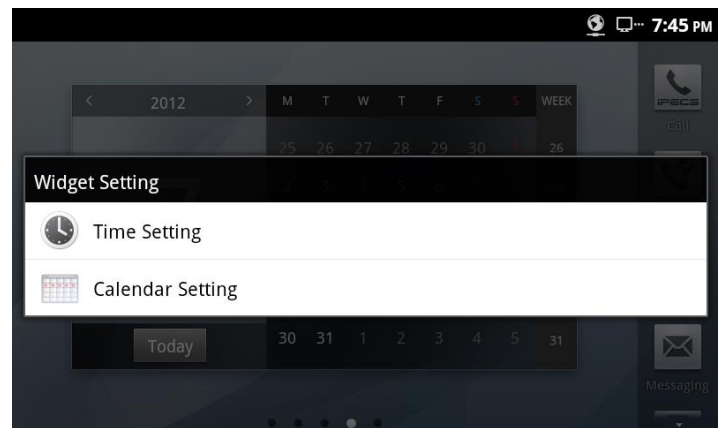

To change the appearance of the time, date or weekday appearance,

1. On a Launcher screen touch the Option menu button.
2. Select 'Widget Setting'.
3. For Date and Time Settings, select the clock format (12/24 hour) and the data format.  
Or  
For Calendar Setting, select the weekday order.
4. Touch the Back button to return to the Launcher screen.

## 5 iPECS Phone

The **iPECS** Phone application is accessed with the icon in the Apps Dock, a Launcher screen or automatically when answering a call. The **iPECS** Phone window is a virtual construction of the functional elements of an advance business telephone. Along the left are the first six (6) programmable 'Flex' buttons. These allow access to CO Lines/Trunks, calls to other stations or activation of an **iPECS** system feature. In the center of the window is the Call information screen that displays information about active, incoming and held calls.

On the right at the top is the Station identifier with the Station Name or number. Below the identifier are menu icons for

- Contacts, section 7.
- Logs w/missed calls, section 8.
- PGM button with access to the Station User Menu, Appendix A.
- Flex buttons access to buttons 7 to 30, section 6.3.

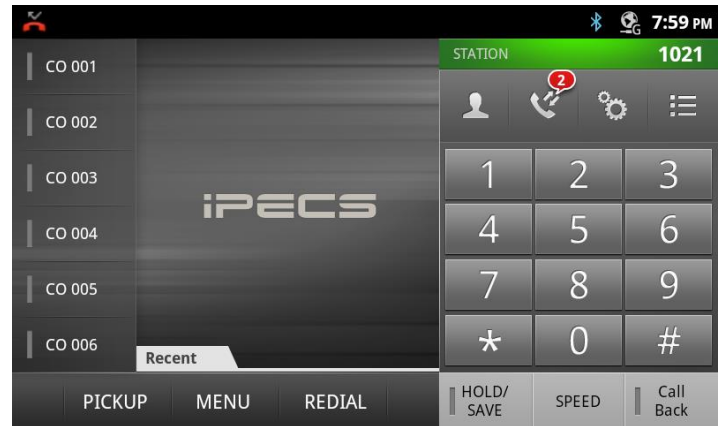

Across the bottom are two menus. In the left menu are three soft keys that are context sensitive and show available call functions from the **iPECS** host. If more than three selections are available a left/right arrow is exposed to access the additional items. The idle mode **iPECS** menu presents:

*Pickup:* answer calls ringing another station.

*Menu:* access the Station User or Phone setting menu, Appendix A and section 5.5, respectively.

*Redial:* redial one of the last 10 dialed numbers.

The second menu is the three fixed **iPECS** phone feature buttons Hold/Save, Speed and Call Back that are discussed in the following sections.

### Note

- Several of the buttons and icons provide multiple functions based on the state of the phone. For example the Hold/Save button places an active call on hold and saves entries made by the user when entering speed dials and other information.
- The Recent call list can display in the Call screen by touching the 'Recent' tab.
- The LIP-9070 does not support legacy iPECS Muted Ring feature. It support through notification message on top bar as "new call wait" with one time beep tone. This is almost same as what normal mobile phone call waiting service.

## 5.1 Speed

### 5.1.1 Using Auto dialing

The **iPECS** system includes several automatic dialing features accessed with the Speed button.

#### *Redial number*

The user selects from a list of the last ten (10) numbers dialed for redialing.

#### *Saved Number Redial*

The user saves a number during a call and then recalls the saved number for redialing.

#### *Directory Dial*

Dial-by-name directories to call other users or dial a Station or System speed dial. Characters are entered with two dial pad digits.

#### *System and Station Speed Dial*

Storage is allocated in the **iPECS** for System Speed dial numbers, numbers available to all system users, and Station Speed dial numbers, numbers available and configured by the station user.

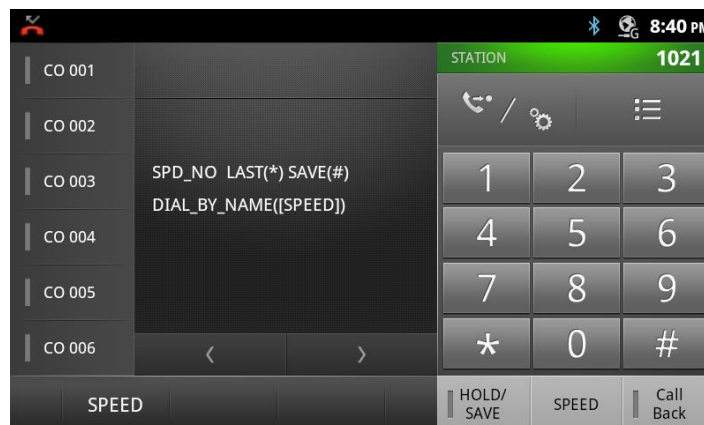

To use an auto dial feature

1. Press the Speed button.
2. Dial the code for the auto dial feature desired.
  - a. To dial a number in a Speed dial, dial the Speed dial bin number.
  - b. Press Call.

A number must be stored in the Speed Dial bin. System Speed numbers are stored by the Attendant. The user may assign Station Speed Dial numbers as detailed in section 5.1.2.

- a. For Redial, press '\*'.
  - b. Select one of the ten numbers from the list.
  - c. Press Call.

- a. For Saved Number Redial, press '#'.
    - b. Press Call.
- A number must be saved during a previous call.

- a. For Directory Dial, press the Speed button a second time.
- b. Select the desired directory, Internal, System Speed or Station Speed.
- c. Use the dial pad to enter characters/scroll.
- d. When the desired Name highlights, select Call.

### 5.1.2 Setting up a Station Speed Dial

Station Speed Dial numbers are somewhat like Contacts except with Speed Dial only a name and a phone number are assigned. The number of bins available will be from 20 to 100 depending on the **iPECS** system. A Speed Dial can be up to 48 digits in length and may include special characters. For more details, see the Feature and Operation manual for the **iPECS** system.

To configure a Station Speed Dial number

1. Touch the PGM button to access the Station User menu.
2. Touch the Speed button.
3. Dial the CO Line/Trunk access code, generally '9'.
4. Dial the Speed Dial bin number (00 to 19 or 00 to 99).
5. Dial the telephone number for the Speed dial.
6. Touch the Hold/Save button.
7. Enter an optional Name using the dial pad with two digits for each character.
8. Touch the Hold/Save button to complete the Speed Dial entry.

## 5.2 Call Back Message Wait

When calling another station in the **iPECS** system and the call is not answered, you can leave a request for a call back and activate an Intercom Message Wait to the called user.

To activate a Call Back message wait

1. While receiving no answer on an internal call, press Call back. A Call Back Message wait is activated and the called station user receives a message waiting indication for the Intercom (ICM) call.

To respond to a Call Back message

1. Press the flashing Call Back button.
2. Select the ICM MWI radial button.
3. Select the Station to call back from the Station message list.

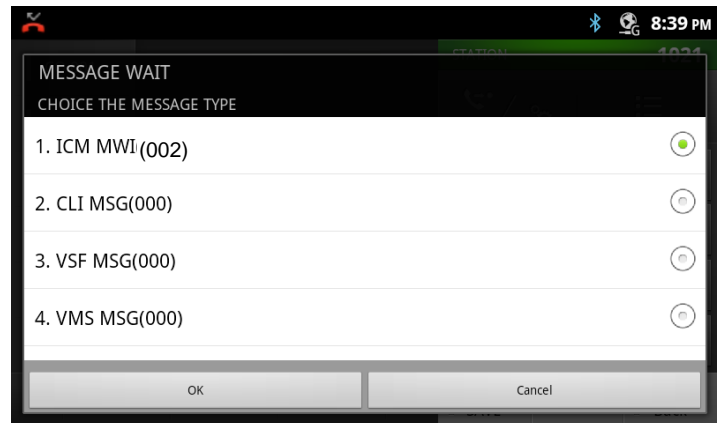

## 5.3 Flex Buttons

Flex buttons, which are programmable, access resources of the **iPECS** such as CO Lines and paging as well as call other stations and activate features of the **iPECS**. Buttons that access external networks such as a CO Line or Loop button are assigned by administrative users only. The user can configure buttons assigned to other functions or unassigned buttons. For details on configuring a Flex button see Appendix A.

In addition to configuring Flex buttons, the user may assign a label to the button as discussed in section 5.5.2

The **iPECS** Phone screen displays the first six (6) Flex buttons on the left of the screen. The remaining 24 buttons can be displayed in the **iPECS** Phone screen using the Flex button icon. The buttons are shown under two tabs, buttons 7 to 18 under tab 1 and buttons 19 to 30 under tab 2.



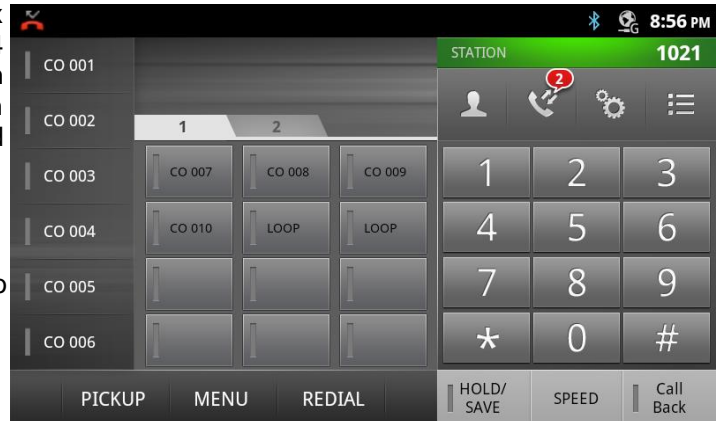

### Note

- Buttons that are not assigned appear with no label in the button display.



## 5.4 Video Calling

Once a voice call is established you can initiate or accept a video call. To start or respond to a Video Call invitation, press the Video Start button, which will open the Video Call window. On the right side of the window is a thumbnail of the video sent from the LIP-9070 and controls for the Video call including:

-  **Frame Rate:** set the frame rate from 5 to 24 frames per second. Higher frame rates improve quality but require higher bandwidth.
-  **Video Screen size:** adjust the size of the main video screen.
-  **Dial pad:** show or hide the basic telephone dial pad.
-  **Transfer:** send the call to another destination.

To the left is the main video screen that displays video sent from the connected party. The video is sent after the party accepts the Video call. Note it may take a few moments to display the received video when the call begins.

At the bottom of the screen are the soft menu buttons. The buttons include,

- Video Stop/Start:** pause and restart video transmission.

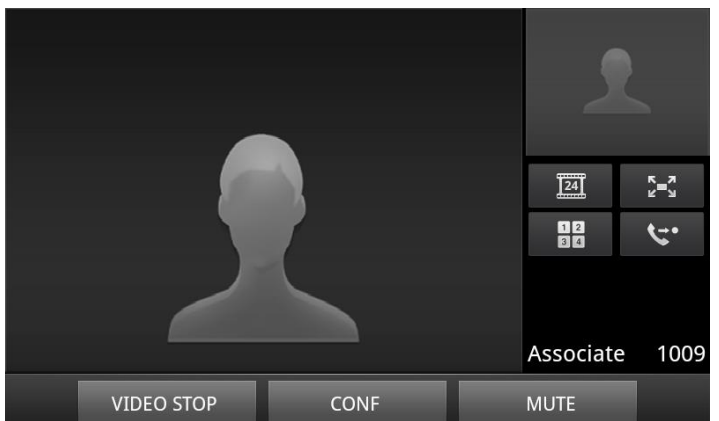
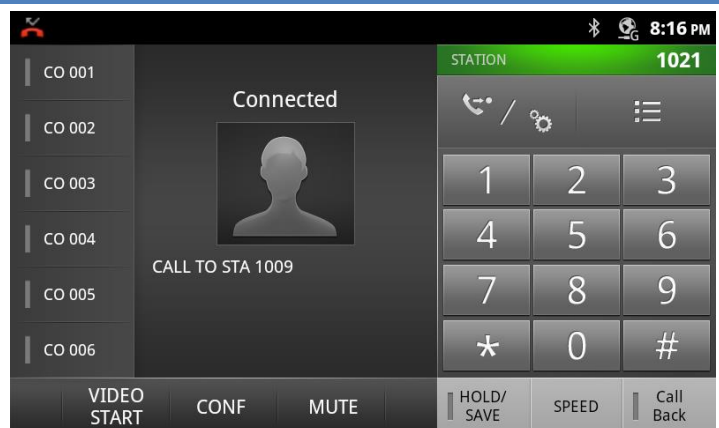



- *Conf*: initiate a voice conference.
- *Mute/Unmute*: turn the microphone on or off, to control the speakerphone, handset or wired headset microphone.

#### Note

- The video call supports multiple video codecs including {H.264, H.263 and, MPEG}. The codec for a given call is negotiated between the devices.
- The LIP-9070 video call function requires below bandwidth based on the codec employed.
  - H.263: 768kbps
  - H.264/MPEG: max=2048kbps, min=384kbps, typical target = 768kbps

## 5.5 iPECS Phone Call Settings

The Call Settings for the *iPECS* Phone impacts call handling, button appearance, sounds and other characteristics of the phone. To view the Call Settings menu,

1. While on the *iPECS* phone screen, touch the Menu button.
2. Select the Call Settings icon.

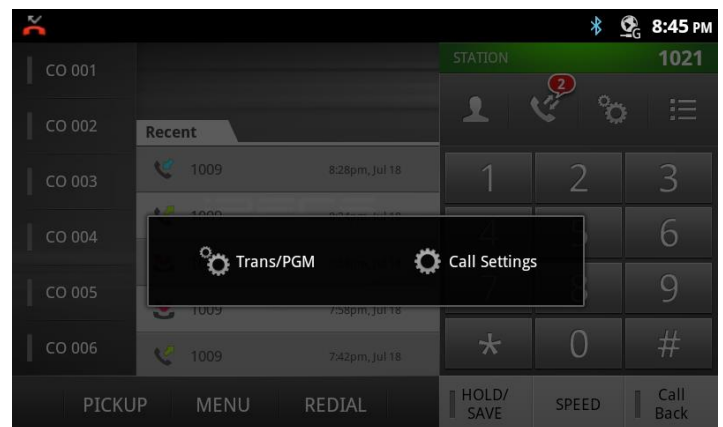

The Call Settings menu includes,

- *Preferences*: section 5.5.1, set signaling and answer for internal calls, configure wired headset operation, etc.
- *Flexible Button Name*: section 5.5.2, assign a name or label for each Flex button.
- *Phone Management*: section 5.5.3; manage characteristics of the phone including the name, password, etc.
- *Sound*: section 5.5.4, select the ringtone for incoming internal and external calls.
- *System Configuration*: section 5.5.5, assigns the *iPECS* system IP address and the connection mode.
- *Reboot*: section 5.5.6, restart the LIP-9070 phone.



### 5.5.1 Preferences

Preferences determine how calls to a busy station are handled, how calls are answered and if calls are sent to the user's mobile phone.

- *Busy Call Waiting*: while the user is busy on a call, new DID and DISA calls can be delivered to the phone or, when disabled, the call routes based on the busy call routing configured in the **iPECS** system.
- *Answer Mode*: set the Intercom Call Answer Mode as HF (Handsfree Answerback to Voice announced calls), Privacy (lift the handset or press the Speakerphone button to answer a Voice announced call) or Tone ring.
- *Headset/Speaker*: configure the audio path when the speaker button is touched, route audio to the headset or speakerphone.
- *Mobile Extension*: send calls to a mobile phone associated with the station.



### 5.5.2 Flex Button Labels

A label or Name, up to 12 characters can be configured for each Flex button by the user. If a label is not configured the default name based on the type button is used.

To configure a button label,

1. In the Call Setting screen, select Flexible Button Name.
2. Select the desired Flex button, scrolling to display the Flex button.
3. Enter the label, up to 16 characters.
4. Press Save to store the label.



### 5.5.3 Phone Management

The user can manage characteristics of the phone including the name, password and number as well as the contact icon and language for the display.

- *Station Name*: set the display name for the station that is delivered to other internal parties during a call, 12 characters.
- *Set Password*: set the phone password, 12 digits.
- *Station Number*: select a desired Station number that will be requested by the phone during registration. If available, **iPECS** will assign the Station the requested number.
- *Video Frame*: adjust the video frame rate.
- *Substitute Image*: change the user's contact icon.
- *Language*: select the display language.



### 5.5.4 Ringtone Sounds

The **iPECS** system includes 14 ringtones in memory that can be used for internal and external incoming call ringtones. To select a ringtone,

1. In the Call Setting screen, select Sound.
2. Select the ICM (internal) or External Ring Group down arrow.
3. Select the desired ringtone.
4. Select 'Done' to save the selection.



### 5.5.5 System Configuration

The System Configuration menu allows input of the IP address for the **iPECS** system and the connection mode (local, remote and local/remote).

To change the system IP address or the connection mode,

1. In the Call Setting screen, select System Configuration.
2. Select the desired item.
3. Enter the IP address or select the connection mode.

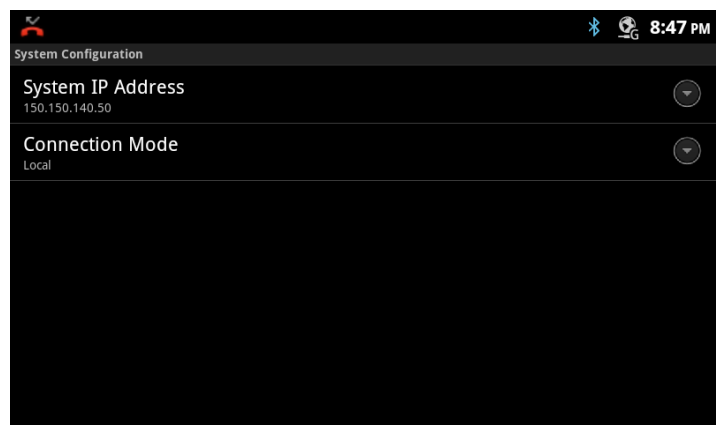

**Note**

- A reboot cycle is required to load the changes into the LIP-9070 active memory.

### 5.5.6 Reboot

After modifying the System Configuration, it is necessary to reboot the LIP-9070. To reboot,

1. With the **iPECS** Phone screen display, select the Menu button.
2. Touch the Call Settings icon.
3. Select Reboot from the Call menu.
4. Select OK to reboot.

The LIP-9070 phone will restart and register with the **iPECS** system.

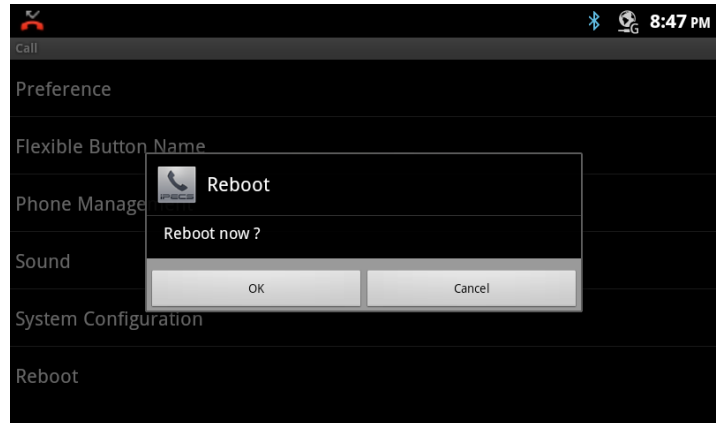

## 6 Working with Contacts

With Contacts users have quick access to a database of up to 1000 commonly called contacts. The database can be searched and communication with a contact established. Users can manage the database, adding, deleting and editing contact information.

Contact information is stored in a VCard format that can be imported to or exported from an SD card or an external Bluetooth device.

The Contacts list is opened with the Contacts icon in the *iPECS* Call window (section 5) or from the Apps Dock (section 4).

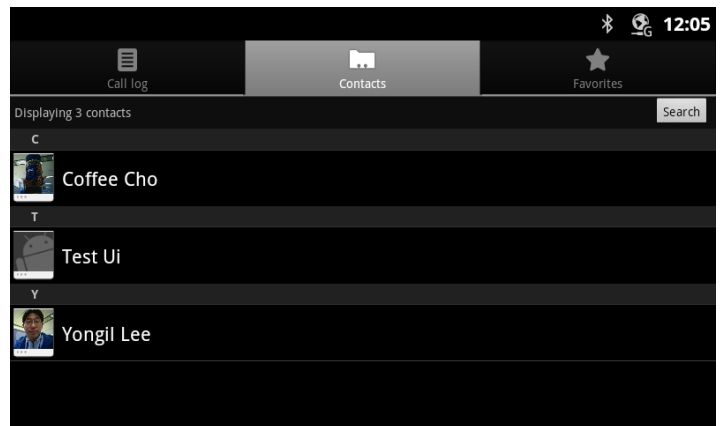

### 6.1 Searching the Contacts

The Contact list can be searched to quickly locate a contact for further activity such as calling the contact.

To search for a contact:

1. Open the Contact app by touching the Contact icon in the Apps Dock or the *iPECS* Call window.
2. Touch the Search button in the upper right.
3. Touch the Search text box to display the soft keyboard.
4. Enter the search text. As characters are entered, matching records display.

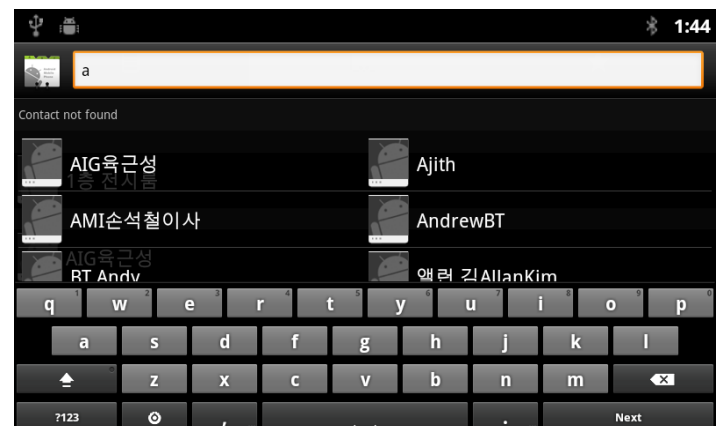

Once located, the Contact can be called or the Contact Option menu can be opened to manage the contact.

### 6.2 Communicating with Contacts

After locating a contact, the contact is selected (tapped) to display the options available for communicating with the contact. When an option is selected, the appropriate screen opens for the communication, the *iPECS* Call window or the SMS screen.

To use Contacts to set up a communication:

1. Open the Contacts list by touching the Contacts icon in the Apps Dock or *iPECS* Call window.
2. Locate and touch the desired contact.

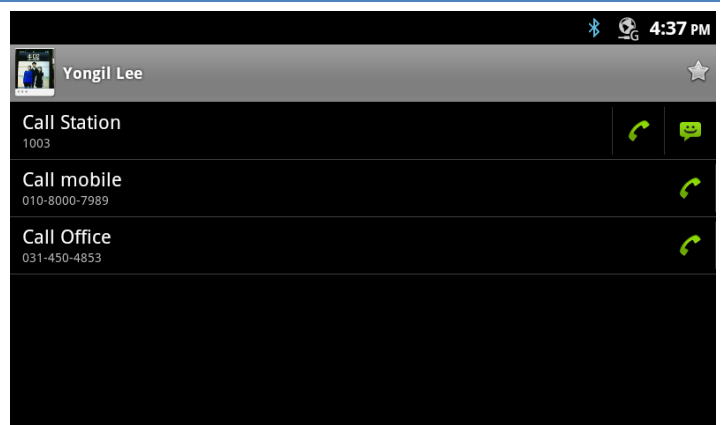

3. Touch the icon on the right to call or send an SMS. The appropriate screen for the communication option selected opens.

The Option menu for the Contact screen includes tools as listed below.

- *Edit Contact*: open the contact information screen for editing.
- *Share*: share the contact information with a connected Bluetooth device, section 6.6.4.
- *Options*: select options for the contact such as send to voice mail, section 6.6.2, and ringtones, section 6.6.3.
- *Delete contact*: delete the contact.

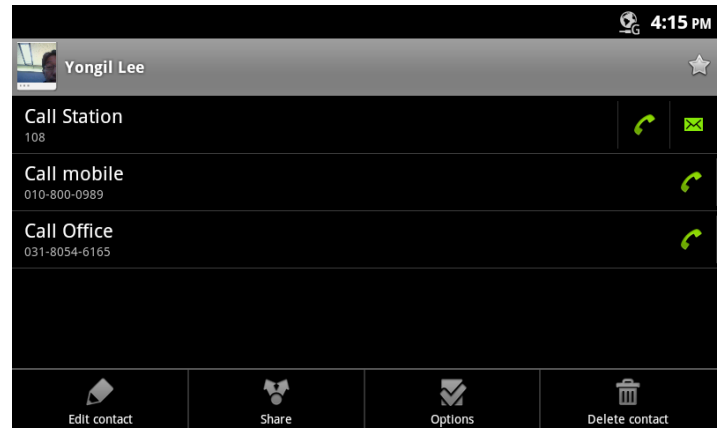

## 6.3 Managing the Contact Database

Contacts are managed through one of two menus. The Contacts list Option menu impacts the Contacts list as a whole and permits contacts to be added, imported or exported.

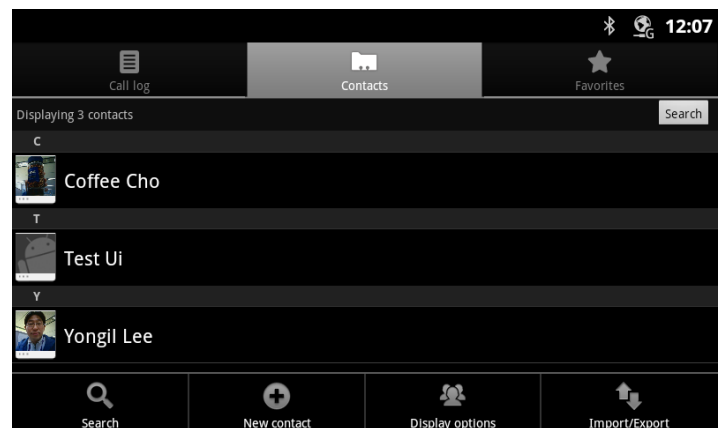

### 6.3.1 Adding a Contact

To add a Contact,

1. Open the Contacts list by touching the Contact icon in the Apps Dock or the *iPECS* Call window.
2. Touch the Menu button.
3. Select 'New Contact'.
4. Touch and complete entries in the 'New' contact form and select 'Done'.



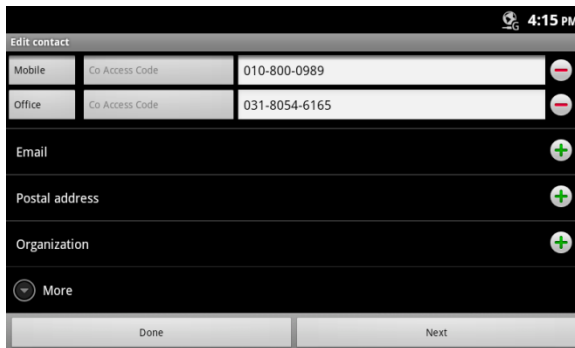

### 6.3.1.1 CO Access Code

When an outside phone number is assigned to a contact, a CO line or trunk is needed to place the call. In this case, the **ipecs** system may require a CO/Trunk Access Code, such as '9', to select a CO Line/Trunk for the call.

Touching the 'Co Access Code' button displays a list of codes available. Select the desired code for use with each external number.

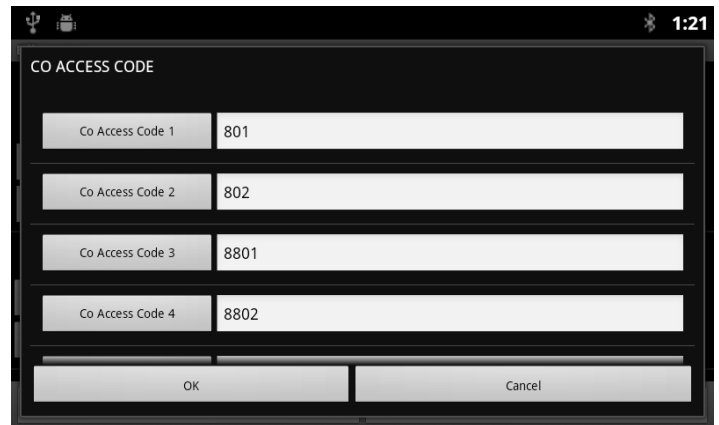

### 6.3.2 Display Options

The Display options determine the displayed records, the sorting options for the Contact list and the way names are displayed.

To change the Display options:

1. Open the Contacts database by touching the Contact icon in the Apps Dock or the **ipecs** Call window.
2. Touch the Menu button.
3. Select 'Display options'.
4. Complete selections in the Display options screen and select 'Done'.

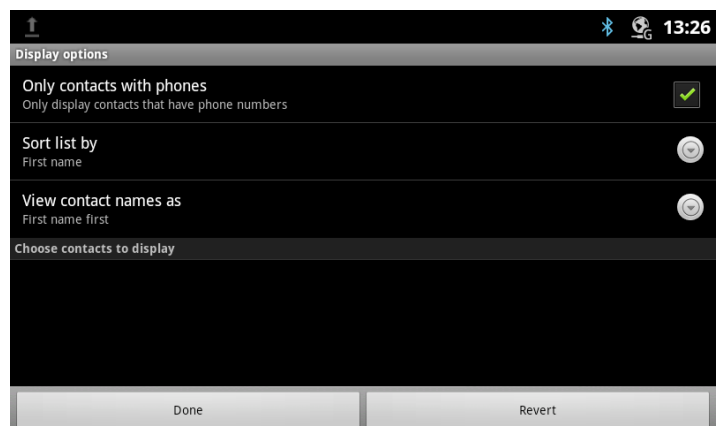

### 6.3.3 Import and Export Contacts

#### Import from SD card

1. Open the Contact application.
2. Touch the Menu button.
3. Select Import/Export.
4. Select Import from Storage.
5. If multiple VCard files exist on the SD card, identify the files to import. The files are imported to the Contacts database.

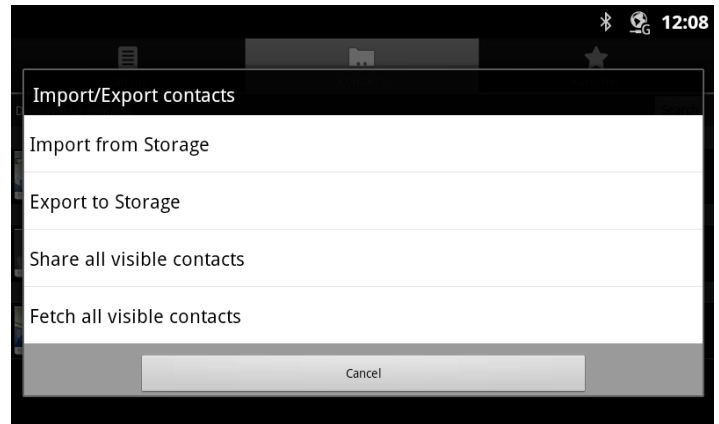

#### Export to SD card

1. Open the Contact application.
2. Touch the Menu button.
3. Select Import/Export.
4. Select Export to Storage.
5. Touch Ok. The contacts are exported as a group VCard file with the vcf file extension. Files are named with the year, month and date with the vcf extension.

#### Import with Bluetooth - Fetch all visible contacts -

1. Open the Contact application.
2. Touch the Menu button.
3. Select Import/Export.
4. Select 'Fetch all visible contacts'.
5. In the popup, select 'Import to Storage (the SD card) or the Contacts database. The phone scans for and displays a list of nearby Bluetooth devices.
6. Select the desired Bluetooth device for the import, the phone imports the V-card files.

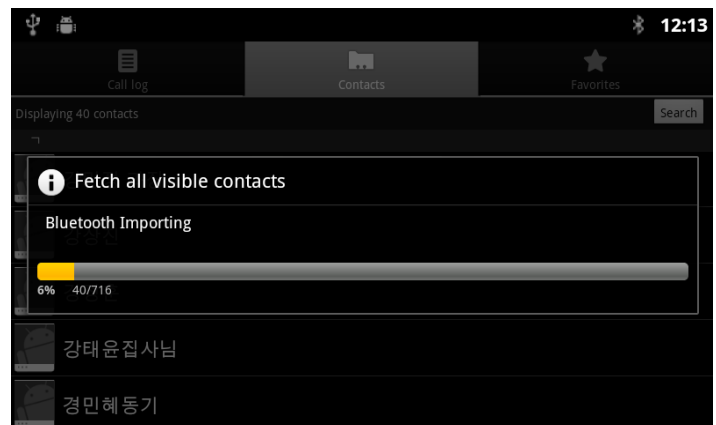

#### Export with Bluetooth - Share all visible contacts -

1. Open the Contact application.
2. Touch the Menu button.
3. Select Import/Export.
4. Select 'Share all visible contacts'. The phone scans for and displays a list of nearby Bluetooth devices.
5. Select the desired Bluetooth device to receive the export, the phone exports the V-card files.



## 6.4 Managing a Contact Record

### 6.4.1 Edit Contact Information

To edit the information for a Contact,

1. Open the Contacts list by touching the Contact icon in the Apps Dock or the *iPECS* Call window.
2. Touch and hold the desired Contact.
3. In the popup menu, select 'Edit contact'.
4. Modify the desired information and press Done.

#### Note

- The 'Revert' button returns to the previous screen.

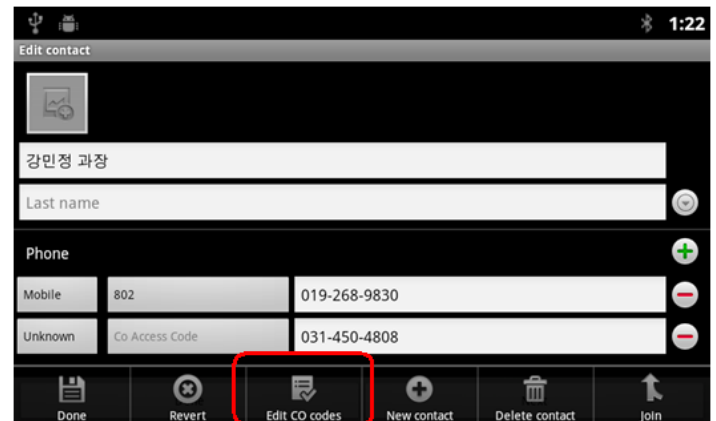

### 6.4.2 Deleting a Contact

To delete a Contact,

1. Open the Contacts list by touching the Contact icon in the Apps Dock or the *iPECS* Call window.
2. Touch and hold the desired Contact.
3. Touch the Menu button.
4. Select 'Delete contact'.

### 6.4.3 Joining Contact records

When Contacts are imported from multiple sources, a contact may have multiple identical records. In this case, a record can be selected and joined with other records.

## 6.5 Favorites

When a large number of Contacts are entered in the database, it can be helpful to have a smaller list of Favorite contacts for quicker access. Contacts marked as a favorite, display when the Favorite tab of the Call Log/Contact screen is selected. The list shows the Favorite Contacts sorted alphabetically followed by a listing of recent calls.

To assign a Contact to the Favorites list,

1. Open the Contacts list by touching the Contacts icon in the Apps Dock or *ipecs* Call window.
2. Locate and touch the desired contact.
3. Touch the star icon to the right of the Contact name to toggle the Favorite status of the contact. The star icon is a golden color for a favorite.



## 6.6 Miscellaneous Contact Options

### 6.6.1 Contact's Default Number

The Contact's default number is used when the contact record is touched and held to place a call or send an SMS. The default number, which can be changed, is marked with a check in the Contact's detailed information.

To change the default number,

1. Open the Contacts or Favorites list.
2. Touch the name of a contact in the list to view the Contact's details.
3. Touch & hold the phone number to use as the default number.
4. Touch 'Make default number' in the Context menu.

### 6.6.2 Send to Voice Mail

Calls from a Contact can be sent to the users Voice mail automatically. The phone is not provided with notification of the incoming call, which is directly routed to Voice Mail. To send calls from a Contact to Voice mail,

1. Open the Contacts or Favorites list.
2. Touch the name of a contact in the list to view the Contact's details.
3. Touch the Menu button and touch Options.
4. Check Incoming calls.
5. Press the Back button.

### 6.6.3 Contact Ringtone

The ringtone received when a call from the contact is received can be customized allowing the user to quickly identify the calling party. To set the ringtone for a Contact,

1. Open the Contacts list by touching the Contacts icon in the Apps Dock or *ipecs* Call window.
2. Locate and touch the desired contact.

3. Press the Menu button and press Options.
4. Select Ringtone.
5. From the scrollable list of ringtones that opens, select the desired ringtone, a sample of the ringtone plays.
6. Touch OK.

#### 6.6.4 Share a Contact

A Contact record can be shared with an external device employing Bluetooth. The record is sent as a Vcf file with the contact's first and last name as the file name (John Smith.vcf). To share a contact,

1. Open the Contacts list by touching the Contacts icon in the Apps Dock or *iPECS* Call window.
2. Touch and hold the desired contact.
3. Press Menu button.
4. In the menu, selecting 'Share this contact' displays the Bluetooth device screen.
5. Select the Bluetooth device to receive the record, the record is sent.

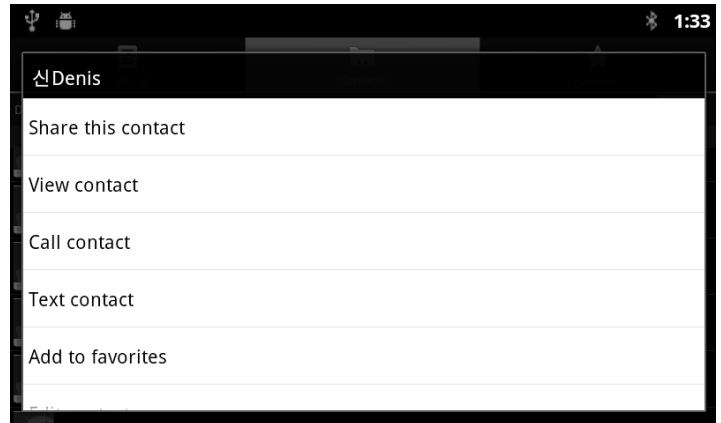

## 7 Call Log

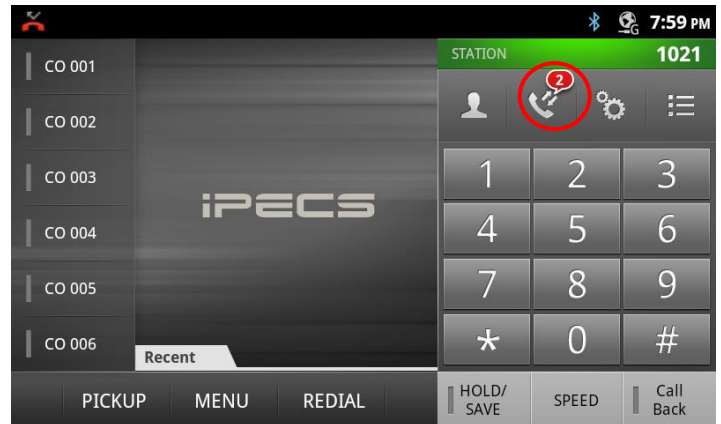

The LIP-9070 maintains a log of incoming, outgoing and missed calls. Up to 500 call records are stored; the oldest record is deleted to provide room for a new record when the record limit is reached. The Log icon indicates the number of new missed calls up to 99 and “...” will display for more than 99.



### 7.1 Viewing the Call Logs

Tapping the Call Log icon in the *iPECS* phone window or from the Call Log icon in the App dock, displays the Log list. The Log list can be scrolled and, from the screen, the user's Contacts and Favorites can be accessed.

In the list, an icon on the left indicates the type of call for the record. When a number has multiple logs, the 'more' icon (⌵) opens a list of logs associated with the number. The call type icons are:

-  Incoming
-  Outgoing
-  Missed

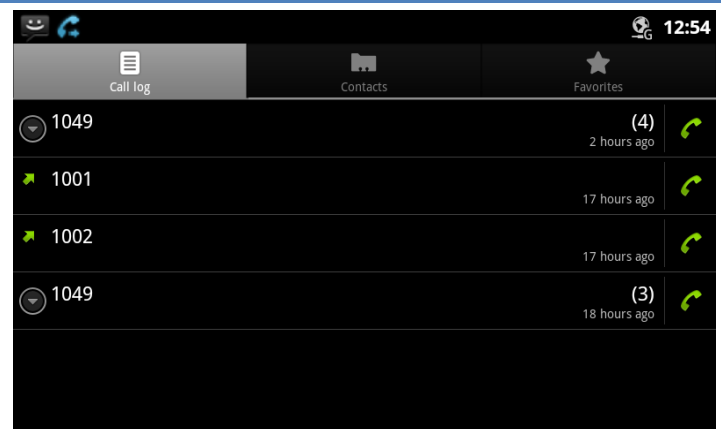

To the right, the list indicates the number of logs associated with a number and when the last log was generated.

### 7.2 Using the Call Logs

To return a call, simply touch the handset icon to the right of the Log entry.

Touching a log displays the actions available for the log. The display will vary for records associated with a Contact and numbers that can receive an SMS text message.

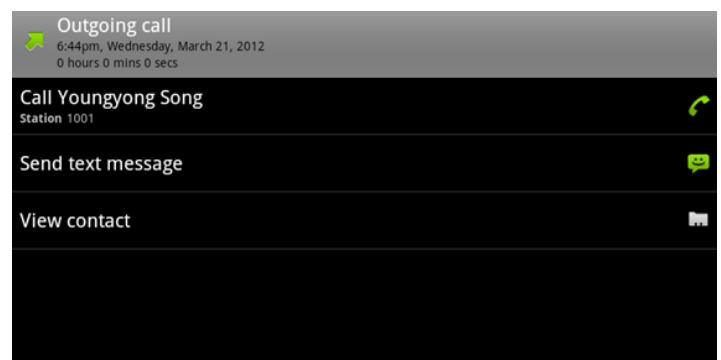

Touch and hold a record to display the Context menu that permits the log to be added to the Contacts or removed from the Call Log. Other options are shown, if available, to send a message or call the number in the log.

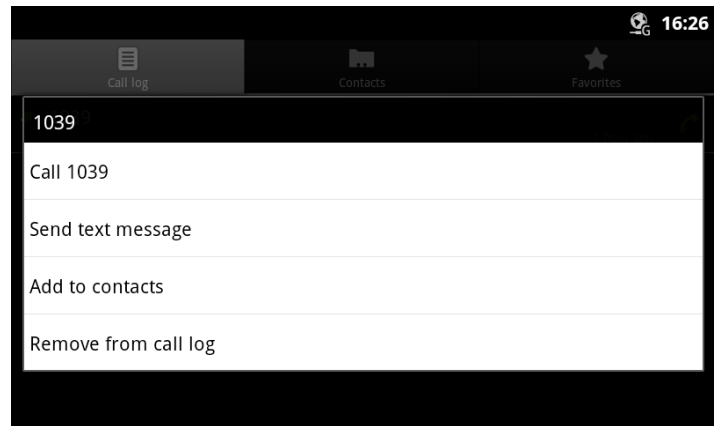

## 8 Using SMS (Short Message Service)

The *iPECS* system incorporates a business SMS application so users of *iPECS* phones including softphones can send and receive short text messages to other users. Each message can be a maximum of 80 characters. With the LIP-9070, messages are stored as a conversation or thread between two specific users and linked for display purposes. That is, all the messages sent to or received from a user or group of users are shown as a single thread in the Messaging screen. Up to 100 threads with up to 100 messages each can be stored.

The Messaging screen is shown when the Message icon in a Launcher screen or in the dock is touched, or when a 'New' message notification is selected from the Notifications screen.

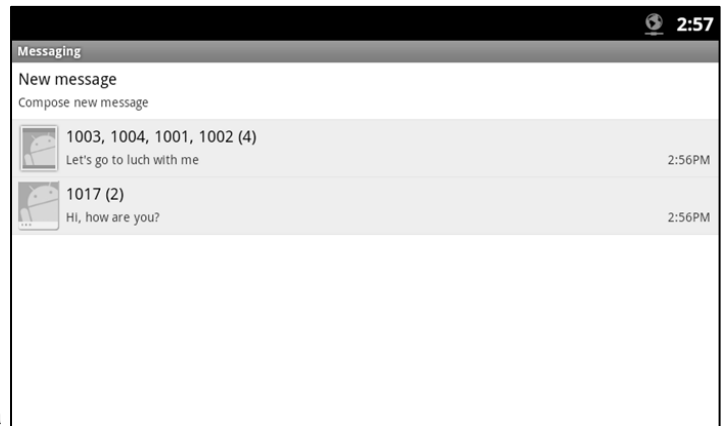

### 8.1 Send a Message

From the Messaging screen or from the Messaging screen Option menu, see section 8.4, a new message can be prepared and sent to up to 4 users.

To send a message,

1. From the Messaging screen select 'New message' or select 'Compose' from the Option menu. The Compose screen appears.
2. Touch the 'To' entry box, a number pad appears.
3. Enter the receiving station number.

Note for a receiver that is a Contact, the qwerty keyboard can be displayed by touching 'ABC' on the number pad, and then enter the name. Matches are displayed for selection as characters are entered.

4. Repeat steps 2 and 3 for up to four (4) receivers.
5. Touch the 'Type to compose' entry box and enter the message. As characters are entered, the number of bytes shown to the right of the box is reduced to provide an indication of the remaining characters allowed.
6. When the message is complete, press Send. The Messaging screen displays with the new message added to the appropriate thread.

Prior to sending the message, the message can be edited, or smiley faces can be added, section 8.1.1.

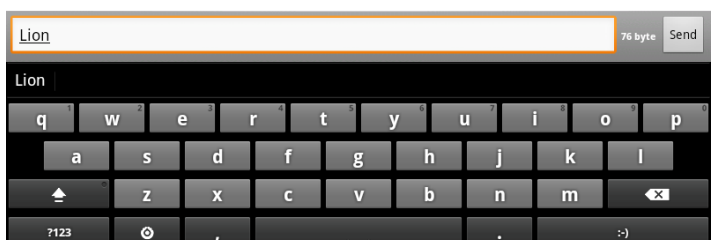
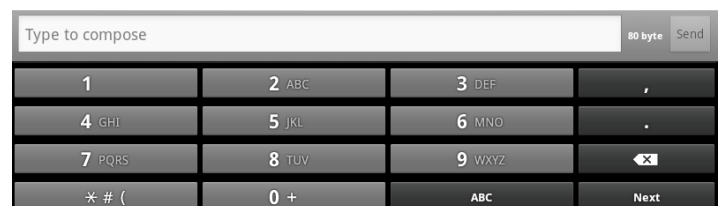

**Note**

- If the message is not properly sent, the warning notice  , displays to the right of the message.
- To hide the keyboard, press the Back button.

### 8.1.1 Options Menu

The Compose screen has an Option menu with the following tools.

- *Send*: send the message.
- *Insert Smiley*: drag and drop a smiley face into the message. A smiley face uses several characters of the message.
- *Discard*: erase the message and return to the Messaging screen.
- *All threads*: save the draft message and return to the Messaging screen. The message is saved and displays on the Messaging screen as a draft where it can be accessed, edited and sent.

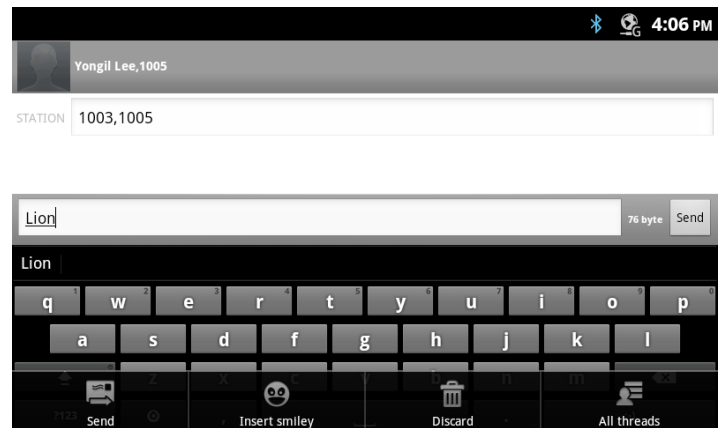

## 8.2 Receive a Message

When a new message arrives, the SMS icon appears in the Notifications bar along with the sender and part of the message. To view the full contents of the message,

1. Drag down the Notifications bar to expose the Notification detail and select the SMS notification.  
or  
Select the SMS icon from a Launcher screen or Apps Dock.
2. Touch the highlighted thread.

The most recent messages in the thread are displayed and previous messages can be viewed with the swipe gesture. The sender of the message is identified followed by the message. Below the sender and message, the time received is indicated.

The thread screen includes the 'Type to compose' box so that the user may quickly compose a return message.

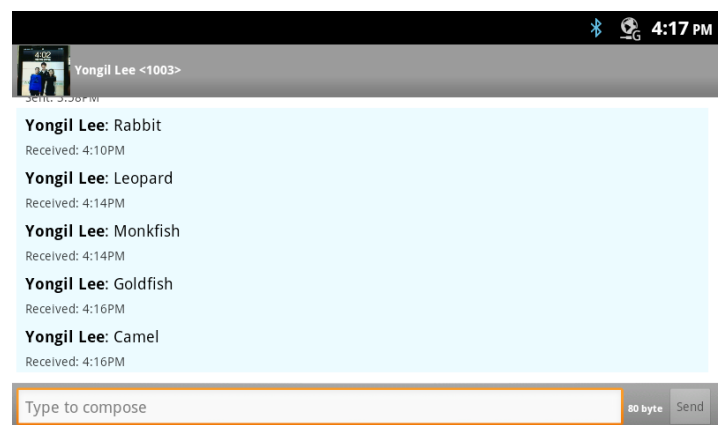
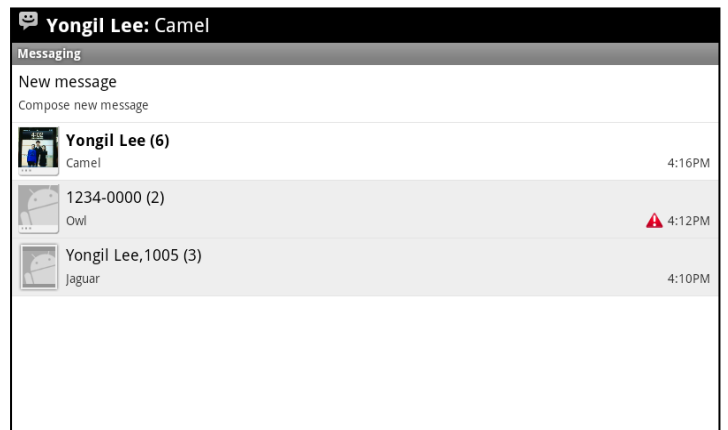

## 8.3 Message Options

Several actions can be taken relative to a message employing the Context menu. To view the menu, touch and hold a message. In the menu, the following tools are available.

- *Lock Message*: lock a message to avoid accidental deletion. If a message is locked, a pad lock icon, , appears to the right of the message record. To unlock a message, touch and hold the message record.
- *Forward*: send a copy of the message to another user.
- *Copy Message Text*: copy a selected message, enter the 'To' user and send.
- *View message details*: view details including date and time sent or received and receiver or sender.
- *Delete message*: delete the message. If the message is locked, an alert is provided before deletion. Also if the message is to/from a user that is not a contact, the user can be added to the Contacts database before deletion of the message.

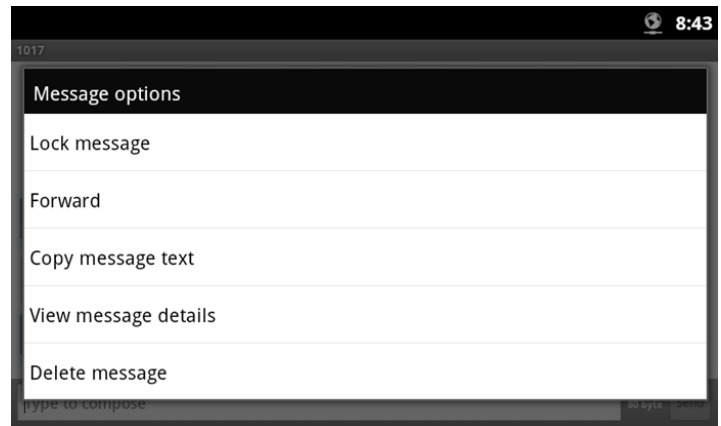

## 8.4 Messaging Screen Options Menu

The Messaging screen Options menu is displayed when the Menu button is touched while viewing the Messaging screen. The Options menu includes the following tools.

- *Compose*: section 8.1, compose a new SMS
- *Delete threads*: section 8.4.1, delete all messages in a thread.
- *Settings*: section 8.4.2, set message retention and notifications

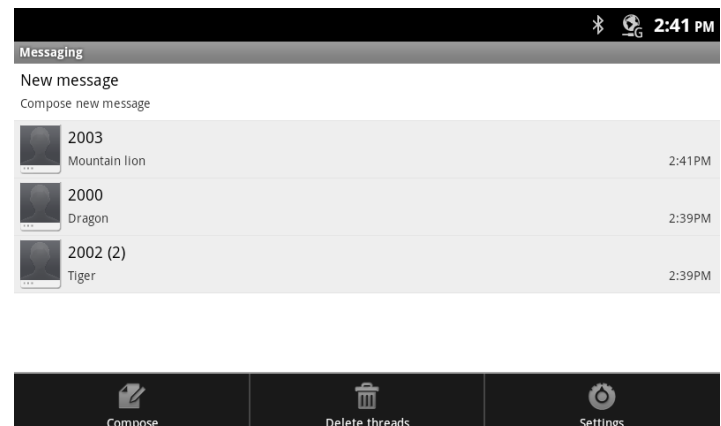



### 8.4.1 Deleting a Message Thread

All messages in a thread can be deleted. When a thread is deleted that contains a locked message, the delete confirmation includes a check box to delete the locked messages as well as the unlocked messages in the thread. In addition, if the sender/receiver is not a contact, a popup menu appears to allow the sender/receiver to be added to the Contacts database.

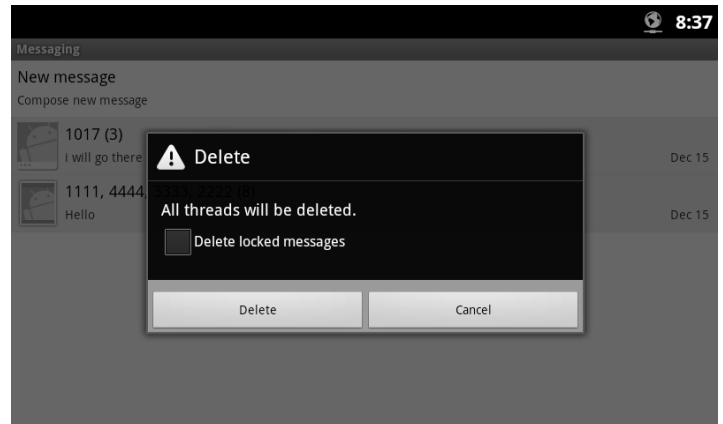

### 8.4.2 Messaging Settings

The Settings for the Messaging screen includes items for managing the message retention and activating new message notification.

- *Delete old messages*: check the box to delete old message when the message limits are reached. If not checked, new messages are ignored.
- *Text message limit*: set the maximum number of messages for each thread, 1 to 100.
- *Notifications*: check the box to receive new SMS message notifications in the Status bar.

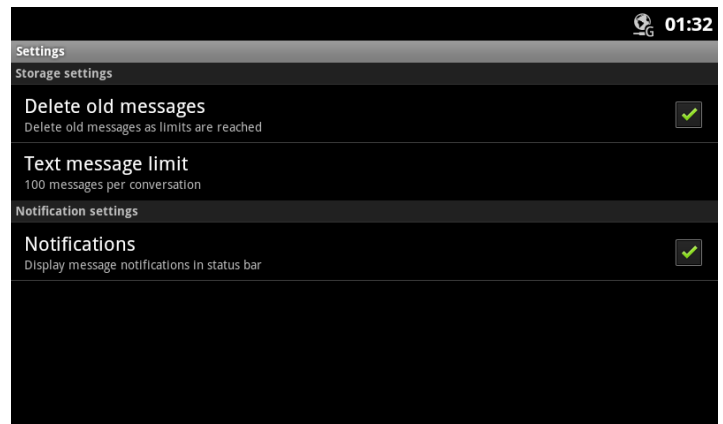

## 9 Appointment/Event Calendar

In the Appointment Calendar application appointments and events are scheduled and reminders for the schedules are assigned. The application sends a notification at the scheduled event reminder times. The Calendar is presented in four (4) views:

- Agenda displays events in chronological order beginning with the next upcoming event.
- Day displays the day's schedule with the hour on the right side and events highlighted over the hours the event is scheduled.
- Week displays the weeks schedules with the hour on the right side, the day across the top and events highlighted over the hours the event is scheduled.
- Month displays the months schedules.

### Agenda View



### Day View

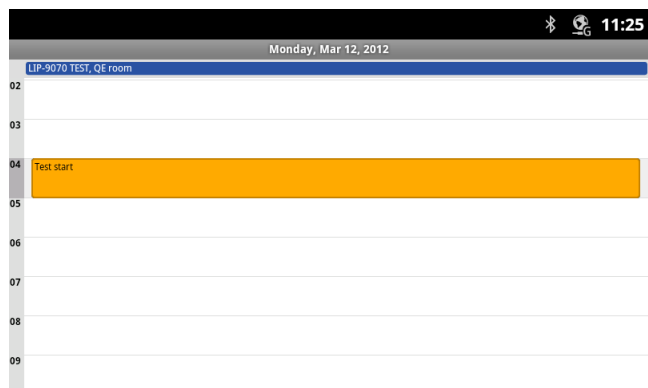

### Week View

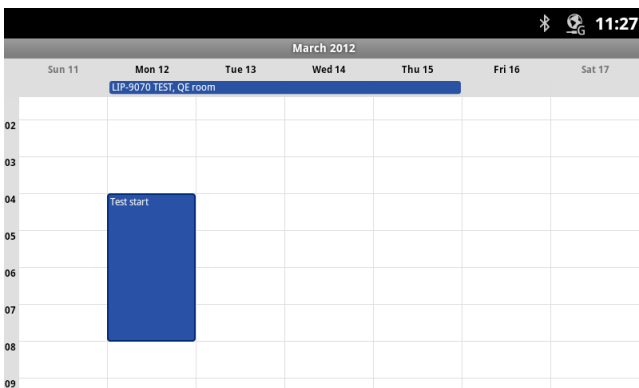

### Month View

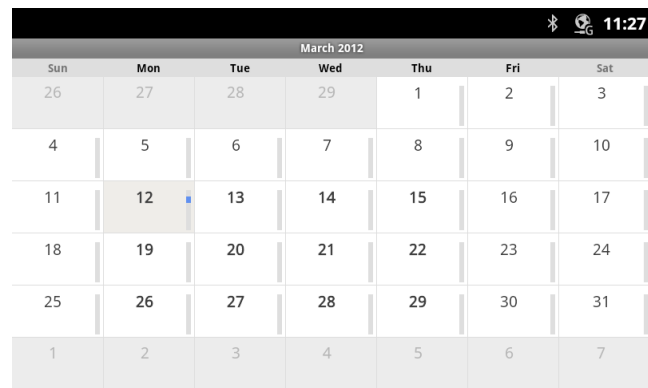

In the Day, Week and Month views, the swipe gesture can be used to display the next or previous Day, Week or Month, as appropriate.

To select the schedule view,

1. Touch the Appointment Calendar icon in a Launcher screen or the Apps Dock.
2. Touch the Option menu button.
3. Select the desired view (Agenda, Day, Week or Month).

### Note

- The Event Calendar does not work with the Google Calendar calendaring service.

## 9.1 Viewing Schedule details

The details of a scheduled event display by touching the event in any of the Schedule views. The details provided include the Event name, Calendar location, the time and date for the event, and the reminder setting.

To view the details,

1. Touch the event to display the details screen.



## 9.2 Managing Schedules

Event schedules can be managed from the day, week or month view using the Context (touch and hold) menu. Also, event schedules can be added from the Options menu of any schedule view.

### 9.2.1 Add an Event Schedule

An event can be scheduled in the Day, Week or Month view with the Context menu or from any view using the Options menu.

To schedule an event,

1. In any view, touch the Options menu button, select 'more' and then select 'New Event'.  
or  
Touch and hold a spot in the Day, Week or Month view.
2. In the popup, select 'New event', the Event details screen appears.
3. In the Event details screen touch and enter the:
  - Event Name,
  - Start time
  - End time
  - Location,
  - Event description,
  - Repetition
  - Reminder, time to begin reminder prior to the actual occurrence, multiple reminders can be assigned
4. Touch 'Done' when finished or 'Revert' to cancel and return to the previous view.

### 9.2.2 Edit an Event Schedule

To edit an event schedule,

1. In the Day, Week or Month view, touch and hold a scheduled event.
2. In the screen Context menu, select 'Edit'.
3. In the popup Event details screen, touch an item and enter new information.
4. Touch 'Done' when finished, 'Revert' to cancel or 'Delete', and return to the previous view.

### 9.2.3 Delete an Event Schedule

---

To delete an event schedule,

1. In the Day, Week or Month view, touch and hold a scheduled event.
2. In the screen Context menu, select 'Delete'.
3. In the popup confirm the deletion or Cancel.

## 9.3 Responding to a Reminder

---

At the scheduled event reminder time, the event notification icon appears in the Notifications and Status bar and, if assigned, the audible reminder tone plays. Also, the event name displays briefly in the Notification and Status bar. The notification icon remains until the notification response.

To respond to a notification,

1. Touch the Notification and Status bar and drag the bar down to display the Notifications screen. The screen displays all active notifications with ongoing events (DND, Forward, Alarms) followed by one-time events such as scheduled event reminders.
2. Touch the notification desired.
3. In the popup select snooze or dismiss  
or, for more than one reminder,  
touch the desired reminder, the event detail screen displays and the notification is cancelled.

#### Note

- When viewing the **iPECS** Phone window, access to Notifications screen is not allowed. Move to another screen to view the notifications or use the Option menu.

## 10 General Purpose Apps

### 10.1 Setting the Alarm Clock

The LIP-9070 includes an Alarm Clock widget. Selecting the Alarm Clock icon (  ) displays the list of Alarms that have been set. Alarms can be set as a single alarm or can be set to repeat on selected days of the week. Alarms can be added, edited, turned on or off, or deleted.

Touch 'Add Alarm' to add an alarm then follow the on-screen instructions. The Alarm time, days of week and state (on/off) for the alarm can be set. An alarm can also be set by touching the Menu button to show the Alarm screen Option menu then touch the Add Alarm or Settings button.

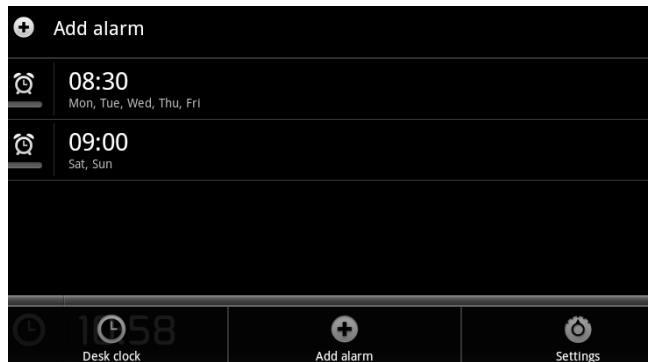

To edit, change the alarm state or delete an alarm, touch and hold the desired Alarm and select the desired function. Then enter the modified alarm information and save the changes.

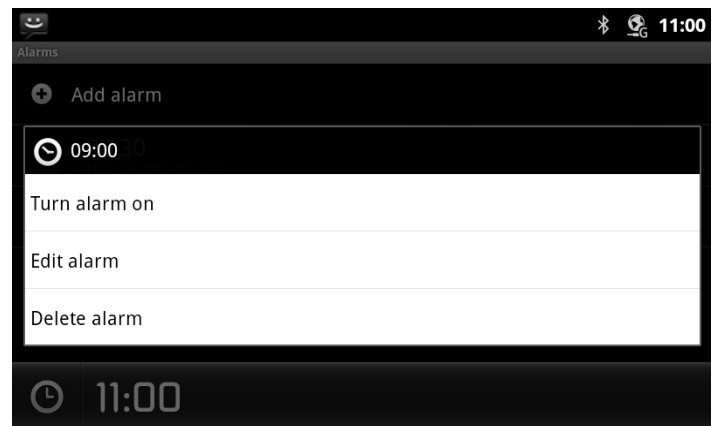

## 10.2 Using the Calculator

The Calculator has the common arithmetic functions and with a left flick, the advanced mathematic function calculator is exposed.

The Calculator icon (  ) opens the basic calculator. Use the keypad to enter digits and the functions buttons to complete an operation. Touch and hold the number in the calculator display to show the Result menu where the results can be copied to other applications or other tools can be accessed.

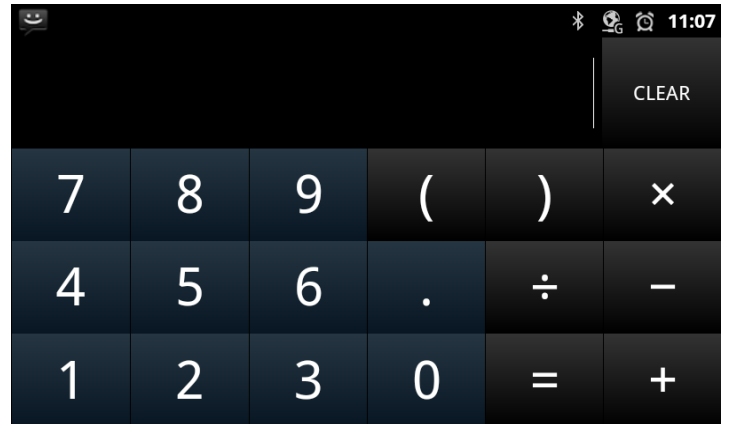

### Note

- Touch clear to erase the last entry or touch and hold to erase the displayed value.
- Left flick on the basic Calculator to show the advanced mathematics function calculator.



## 10.3 Handling Pictures and Videos

Pictures and videos have two associated applications. The Camera application takes pictures and records videos with the built-in camera. Pictures and videos are stored on the SD card and can be shared. In addition, pictures can be used as wallpaper or a user contact icon. The Gallery application organizes pictures and videos into albums that can be viewed and managed.

The camera is a 1.3 Mega-pixel CMOS camera and can be tilted manually for the best view. Pictures taken by the Camera are stored as the jpeg file type. Videos employ the 3GPP file types.

### 10.3.1 Taking Pictures

Touching the Camera icon in the App Dock or on a Launcher screen, opens the Camera screen in the landscape orientation. The right side of the screen includes several controls.

*Picture Thumbnail:* displays a thumbnail of the last picture or Video in the upper right of the screen.

*Picture/Video Control:* switch the Camera mode between still shots or video.

*Shutter/Record:* take picture or start/stop video recording.



To take a picture,

1. Frame the subject in the display.
2. Touch and hold the shutter icon. The camera focuses on the subject and takes the picture.

The picture is displayed for several moments then the display is cleared and a thumbnail of the last picture displays in the upper right of the screen.

### 10.3.2 Recording Videos

As a default, when the Picture application opens, the camera mode is set for single shot pictures. By changing the camera mode, videos up to 30 minutes in length can be recorded. To record a video,

1. Change the Camera control to the Video Camera.
2. Touch the Record button. The video recording starts with the recording duration displayed at the bottom left of the screen. Once complete a thumbnail of the video displays in the upper right corner.

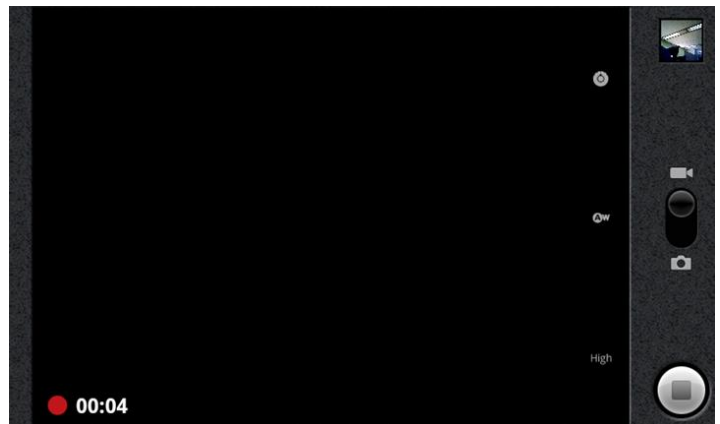

To stop recording video,

1. Touch the Record button.

#### Note

- Videos and pictures taken with the camera are stored in the user dedicated 2G memory.
- A video can be a maximum of 30 minutes.

### 10.3.3 Picture and Video Controls

Various controls are available for pictures and videos. Touching the picture displays the controls including,

*Zoom:* expand the picture with the adjusted zoom, 1 to 4x.



*White balance:* adjust the white balance for the ambient lighting



*Exposure, Quality & Color:* set exposure duration, quality of picture and color effects

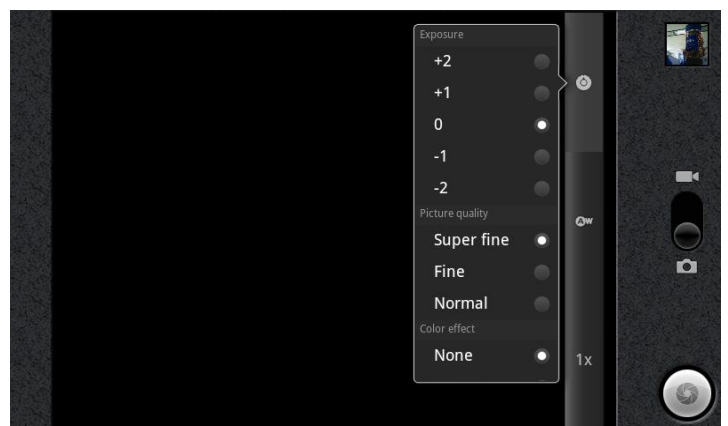



### 10.3.4 Review Pictures and Videos

Pictures and videos stored in the Camera application memory, can be viewed, edited, deleted or shared. The Pinch gesture can be used to control zoom and, if the left/right arrow displays, the Flick gesture will display the next/previous picture.

The Picture review screen opens when a thumbnail in the upper right corner of the Camera screen is touched. The screen includes the following Picture tools.

- *Share*: share the picture with a Bluetooth device, the Bluetooth device selection screen will appear.
- *Delete*: delete the picture, a confirmation is required.
- *More*:
  - *Details*: display details for the picture including name, type of file, date and album.
  - *Set as*: configure the picture as a contact icon or as the wallpaper. The picture will be sized to fit the Contact icon or Wallpaper screen size.
  - *Crop*: crop the picture and save as a new picture in the Album.
  - *Rotate Left*: rotate the picture 90° counterclockwise.
  - *Rotate Right*: rotate the picture 90° clockwise.
  - *Settings*: enable subtitles and the select font for the subtitles.

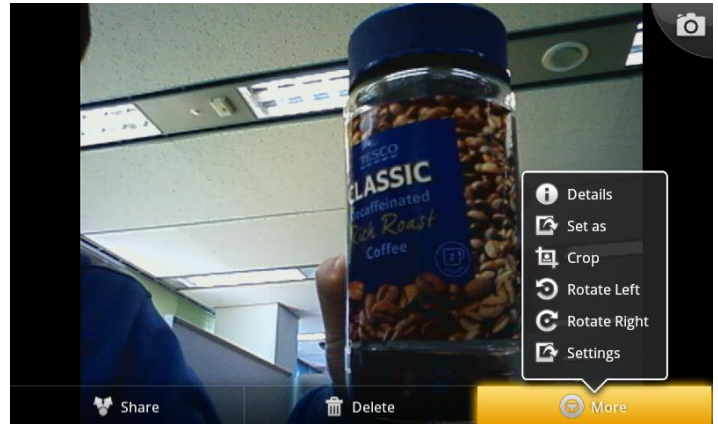

To return to the Camera, touch the Camera in the upper right corner of the review screen to take a picture.

### 10.3.5 Using the Gallery and Albums

The Gallery application organizes and displays picture albums on the SD card and in the Camera. Items in the album are shown in a grid view with thumbnails of each picture or video. The Gallery displays files of the JPEG, PNG, BMP and GIF types as pictures and H.263, H.264 and MPEG4 files as videos. At the top of Gallery screen is the name of the Gallery and, at the top right, is the View Control. At the bottom is the navigation control to view the next or previous album. The navigation displays thumbnails for additional pictures and videos organized by date.

- *View Control*:
- *Slideshow*: show all pictures in album as a slide show.
- *Multiple select*: select multiple items to share or delete.

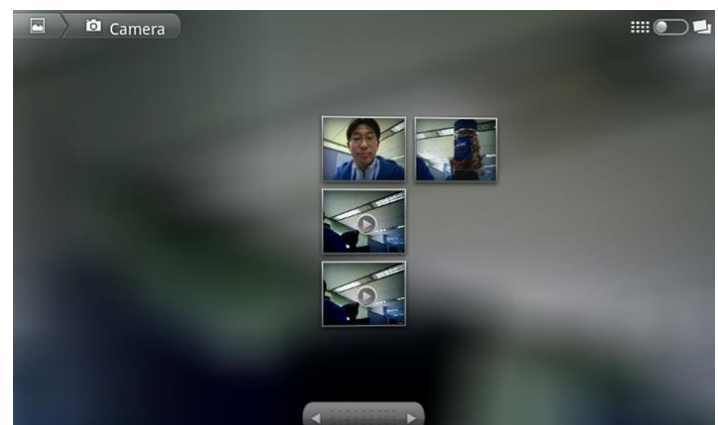

### 10.3.5.1 Viewing a Slide show

When the Slide show view is selected in the Gallery, the Slide show screen appears. Each picture and first video frame display. Each is displayed for about 2 seconds and the next picture or video displays. Videos display with the play arrow, when touched the video plays. The navigation arrow is used to view the next or previous picture in the album. In addition, the Picture tools are available under the Menu button to modify the picture.

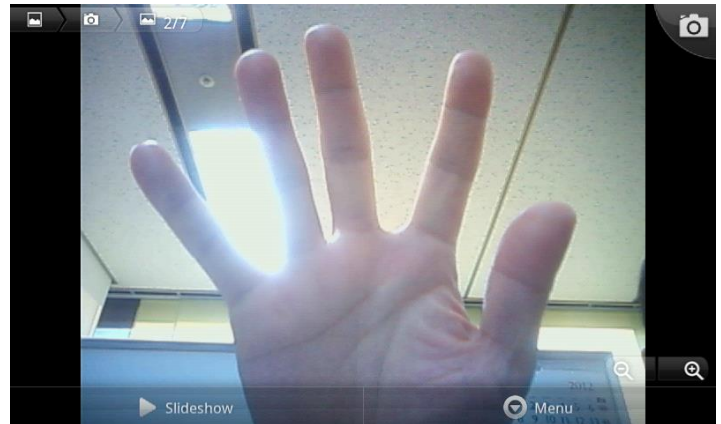

### 10.3.5.2 Selecting Multiple Pictures

Multiple pictures can be selected with the 'Multiple select' view. Once selected, the pictures can be shared with a Bluetooth device or deleted.

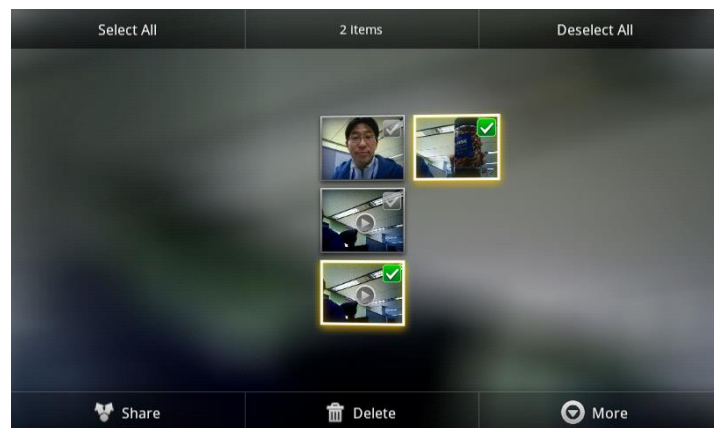

### 10.3.5.3 Viewing Pictures

In the Gallery, pictures can be selected for display. To display a picture,

1. Touch the picture thumbnail.



### 10.3.5.4 Picture Gallery Tools

The Picture tools are available in the Gallery to allow the picture to be modified, used as a contact icon or wallpaper, etc.

While viewing the picture, touch the picture or press the Menu button in the Slideshow screen to display the Picture tools.

- *Share*: share the picture with a Bluetooth device, the Bluetooth device selection screen will appear.
- *Delete*: delete the picture, a confirmation is required.
- *Details*: display details for the picture including name, type of file, date and album.
- *Set as*: configure the picture as a contact icon or as the wallpaper. The picture will be sized to fit the Contact icon or Wallpaper screen size.
- *Crop*: crop the picture and save as a new picture in the Camera Album.
- *Rotate Left*: rotate the picture 90° counterclockwise.
- *Rotate Right*: rotate the picture 90° clockwise.
- *Settings*: enable subtitles and the font for the subtitles.

If a picture is modified, it can be saved in the Camera Album without affecting the albums on the SD card.

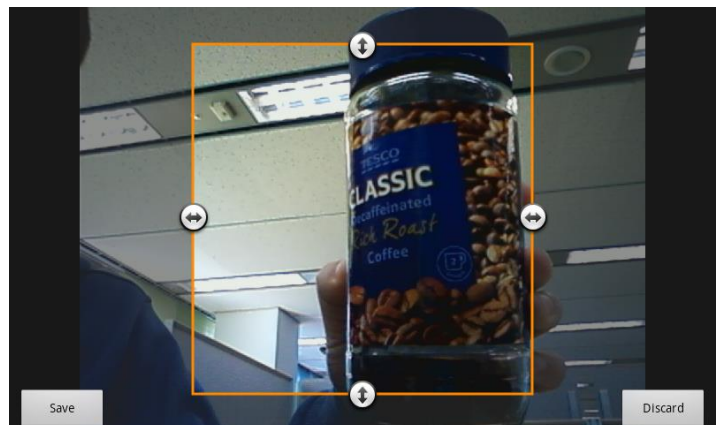

### 10.3.5.5 Viewing Videos

In the Gallery, videos can be selected for display. To display a video,

1. Touch the video thumbnail. The initial frame in the video displays.
2. Touch the video frame to display the Video controls for fast forward or reverse as well as the play-pause control.



## 10.4 Playing Music

The Music application organizes, manages and plays music and other audio files located on the SD card. When the Music icon in the Dock or Launcher screen is selected, the Music app builds a Music Library from information in the audio files (MP3, MIDI and OOG Vorbis formats) on the SD card. Constructing the catalog takes a short period of several seconds or longer depending on the number of files on the SD card. When complete, the Music Library screen opens where music is cataloged and sorted by Artists, Albums, Songs, Playlists and 'Now' playing. To view the contents of a list, select the tab.

Music can be selected ad hoc, from an album or playlist, or randomly selected.

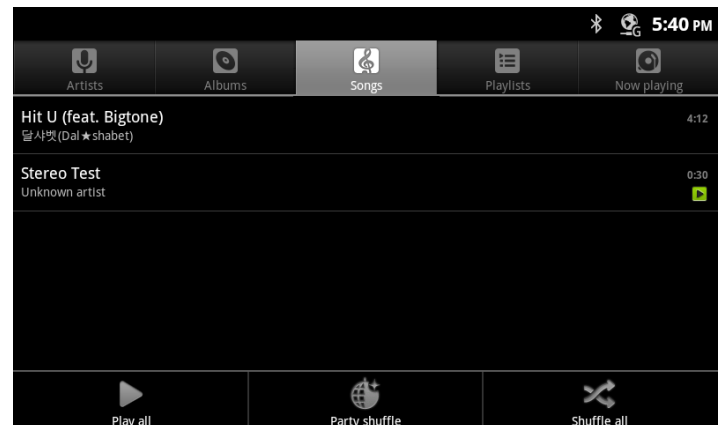

The Music Library screen Option menu varies slightly based on the specific library in view. The menu has song shuffling tools appropriate for the view.

### Note

- Albums may include a tag indicating a Gallery photo to use as the Thumbnail. If the tag is included, the LIP-9070 will display the thumbnail.

### 10.4.1 Playing Songs

To play a song, select a song or playlist from the Music Library, or in the Songs or Album list, press Menu and Play All. The playback screen appears and the song plays over the speaker of the phone.

At the bottom of the playback screen is the progress bar indicating the playback time and total length of the song. Above the progress bar are the common next and previous track controls along with the pause/resume button.

On-screen is information from the files such as album cover, artist, song, etc. In addition, there are three icon *tools*,

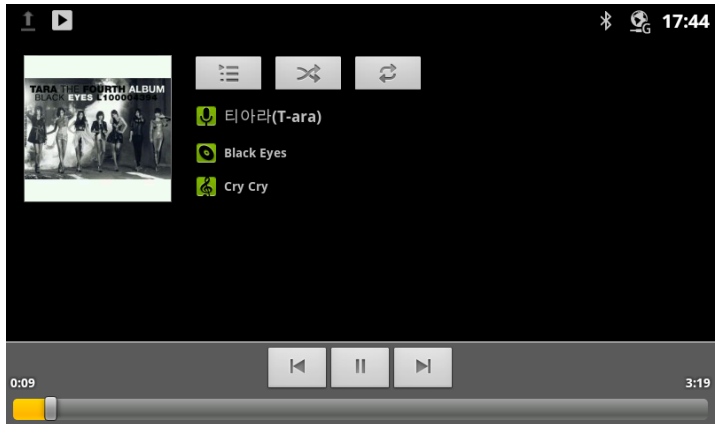

 *Playlist*: open the current Playlist.

 *Shuffle*: shuffle the current playlist for random order playback.

 *Repeat*: repeat the current song, album or playlist.

#### Note

- The music will continue to play even when you switch applications. Music stops when the last song in the playlist is reached, unless the repeat option is active, or if playback is stopped by the user.

### 10.4.2 Playing a Party-Shuffle

When Party Shuffle is selected, the LIP-9070 plays songs from the SD card in a random order. To play a Party Shuffle,

1. In the Music Library screen, touch the Menu button
2. Select Party Shuffle. Twelve tracks are selected at random from the SD card and played as the current Playlist. When the dozen tracks are completed, another twelve tracks are selected and played.

If desired, a song can be added to the Party Shuffle playlist. To add a song to the end of the current Party Shuffle playlist,

1. In the Music Library, touch and hold a song from a list.
2. Touch the Menu button
3. Select 'Add to Playlist' and select 'Current Playlist'.

### 10.4.3 Play songs from a Playlist

To play songs in a Playlist,

1. In the Music Library, select Playlist.
2. Select the desired Playlist. Songs in the Playlist are played.



## 10.4.4 Managing Playlists

A Playlist is a set of songs that have been organized in a group. Songs in the Playlist are played in the order entered in the Playlist or the list can be shuffled before playback.

### 10.4.4.1 Create a Playlist

To create a new Playlist,

1. From a Library, touch and hold the first song title to add to the new Playlist.
2. In the menu touch 'Add to Playlist'.
3. Touch 'New' in the popup menu and enter a name.
4. Touch Save.

A song currently playing in the playback window can be added as the first song in Playlist

1. In the playback screen touch the Menu button.
2. Touch 'Add to Playlist'
3. Touch New in the menu and enter a name.
4. Touch Save.

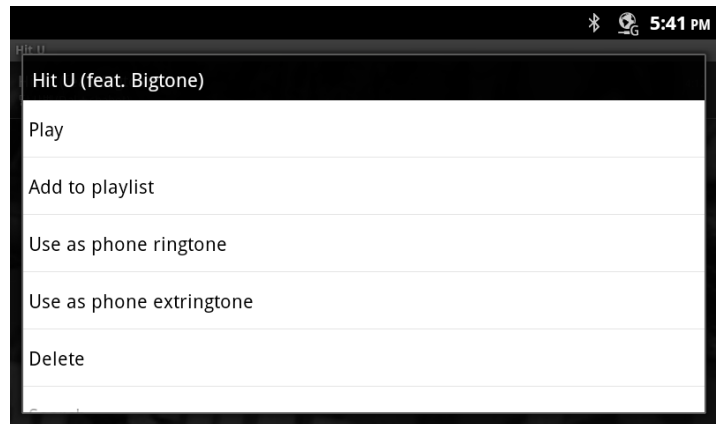

An entire Album can be saved as a Playlist as follows.

1. From the Music Library, select a list and touch and hold a song title from an Album.
2. From the menu touch 'Save As Playlist'.
3. In the popup, enter a name.
4. Press Save to store the new playlist.

### 10.4.4.2 Add Songs to a Playlist

To add a song to a Playlist,

1. From a Library list, touch and hold a song title.
2. Touch 'Add to Playlist'.
3. Select the Playlist to receive the song, the song is added to the Playlist.

A song that is playing can be added to a Playlist as follows,

1. While the song is playing in the Playback screen, touch the Menu button.
2. Select Add to Playlist in the menu.
3. Select the Playlist to receive the song.

#### 10.4.4.3 Rename a Playlist

---

To rename a Playlist,

1. Touch and hold the Playlist from the Music Library.
2. In the menu, touch Rename.
3. Enter the new name for the Playlist.

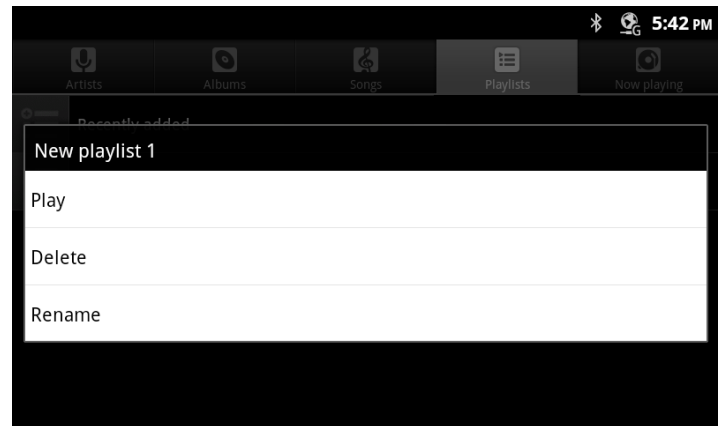

#### 10.4.4.4 Delete a Playlist

---

To delete a Playlist,

1. Touch and hold the Playlist from the Music Library.
2. In the menu, touch Delete.

#### Note

- The 'Recently Added' item in the Playlist cannot be deleted.

#### 10.4.4.5 Delete Song from Playlist

---

To delete a song from a Playlist,

1. Select the Playlist from the Music Library.
2. From the list, touch and hold the song to delete.
3. In the menu, select Remove from Playlist. The song is removed from the playlist but remains on the SD card.

#### 10.4.5 Delete Songs from SD Card

---

Individual songs can be removed from the SD Card. To remove a song from the SD card,

1. Select a Music Library.
2. From the list, touch and hold the song to be deleted.
3. In the menu, select Delete, the song is deleted from the SD card.

#### 10.4.6 Use as Ringtone

---

A song in the Music library can be assigned for use as a Ringtone. To assign a song as a Ringtone,

1. Select a music library.
2. From the library list, touch and hold the song to be used as a Ringtone.
3. In the menu, select Use as Desk Phone ringtone.

Or

1. During playback of a song, press the Menu button.
2. In the menu, select 'Use as Ringtone'.

## 11 Managing Bluetooth

LIP-9070 can interface with several types of Bluetooth devices. For handling files and contacts, a Bluetooth storage device can be selected to share files. For voice, two profiles are available, headset and handsfree.

### 11.1 Bluetooth Headset

The headset connection delivers **iPECS** phone audio to the Bluetooth headset paired with the LIP-9070. The headset icon appears in the main screen and, when the headset icon is touched during a call, the audio is delivered to the headset and the icon illuminates. Touching the active headset icon disconnects the call. When the handset is lifted, the active voice device is changed to the handset. Also, the **iPECS** can be configured to deliver ringtone to the headset in place of the speaker. In this case, if the headset is active, ringing and audio are sent to the headset.

The following is a list of known compatible headsets

- Plantronics M155
- Plantronics M50
- Plantronics M20
- Plantronics Discovery 975
- LG HBM-260
- Samsung HM1700
- Motorola HX550
- Jabara EASYGO; user might experience a connection tone for several seconds after the call is connected
- Jabara EXTREME2

#### Note

- Use of a stereo headset is not recommended as call progress tones (dial tone, ring back tone, etc.) may be distorted.

### 11.2 Bluetooth Handsfree

The LIP-9070 can be configured to function as a Bluetooth headset for an external Bluetooth Audio Gateway (AG) device that supports the Bluetooth Handsfree Profile such as a mobile phone. In this case, audio from the external Bluetooth device is sent to the LIP-9070 over the Bluetooth connection. The Bluetooth HF profile permits the LIP-9070 to receive Caller Id, support Call Waiting and place outgoing calls using the external Bluetooth AG.

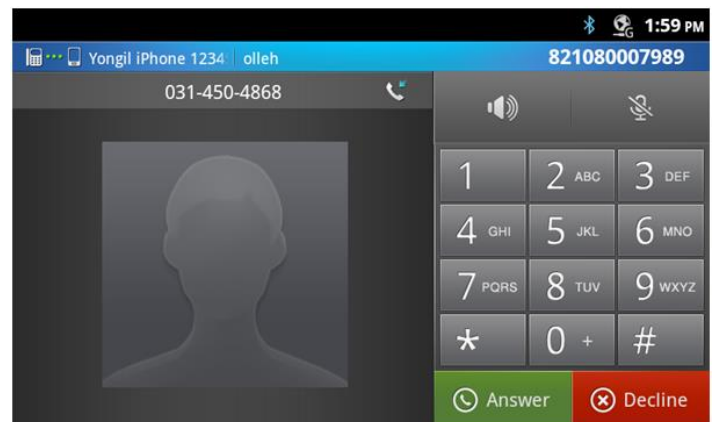



When the Bluetooth HFP application is activated by touching the HFP icon, the HFP call screen appears. Below the Notification and Status bar, the screen displays information for the connected Bluetooth AG including the device name, service name and mobile number. To the left is the connected caller id and icon. To the right are the audio controls for the speaker and microphone of the LIP-9070, a dial pad and the call controls.

#### Note

- A warning message will appear if the Bluetooth HF device is not connected or disconnects unexpectedly.
- As a default, the Bluetooth Handsfree icon is not assigned to a Launcher screen or the Apps Dock. To activate the application the icon must be added to a Launcher screen or the dock.
- The redial feature may not be available on mobile phone.
- Smart Phones employ different noise reduction and automatic gain control algorithms that may affect the voice quality when switching to the Bluetooth HFP operation.

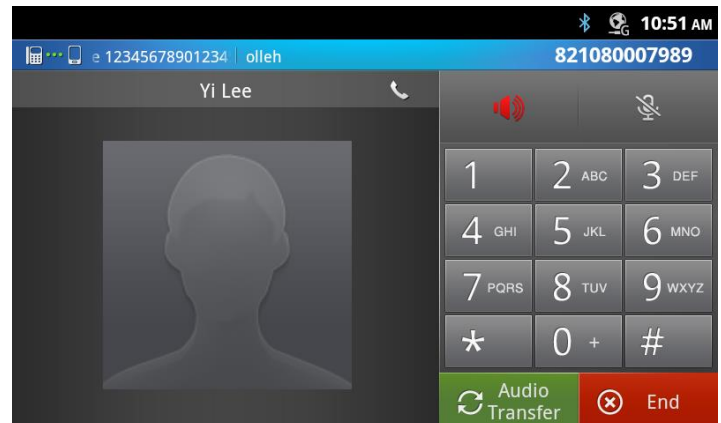

### 11.2.1 Bluetooth HF Call Waiting

The Bluetooth AG will deliver caller id to the LIP-9070 over the Bluetooth connection. The LIP-9070 will compare the caller id with the Contacts and, if matched, the Contact name and icon display. Should a second call arrive, the Bluetooth device sends information for the waiting call. The caller id is displayed, as shown here. The user may select to ignore the call, place the existing call on hold and answer the new call, or end the existing call and answer the new call.

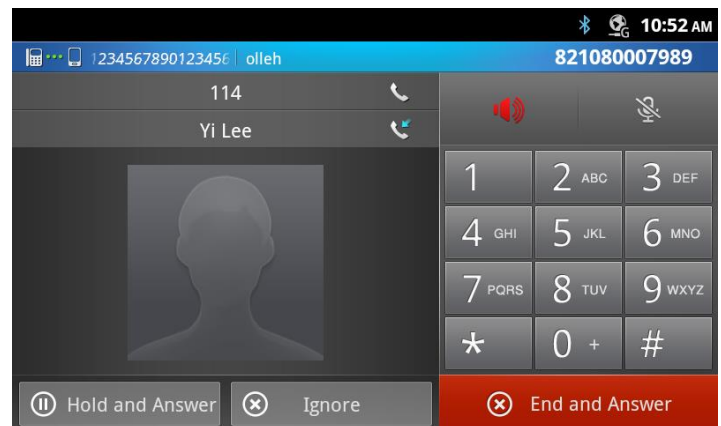

If the existing call is placed on hold and the new call answered, the user can switch between the two calls by touching the Swap button.

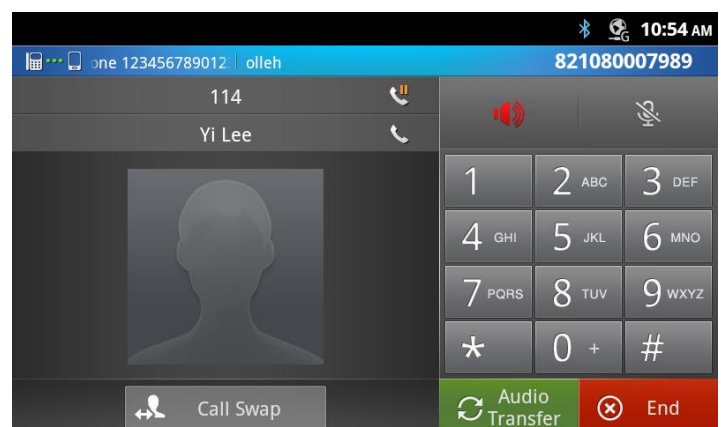

### 11.2.2 Outgoing HFP call

With the Bluetooth HF profile, the LIP-9070 can place an outgoing call using the Bluetooth AG. Digits dialed from the dial pad display. Matching contacts are also displayed and can be selected for dialing. Touching the 'Call' button signals the Bluetooth AG to place the call.

#### Note

- The Backspace icon , can be used to delete dialed digits.

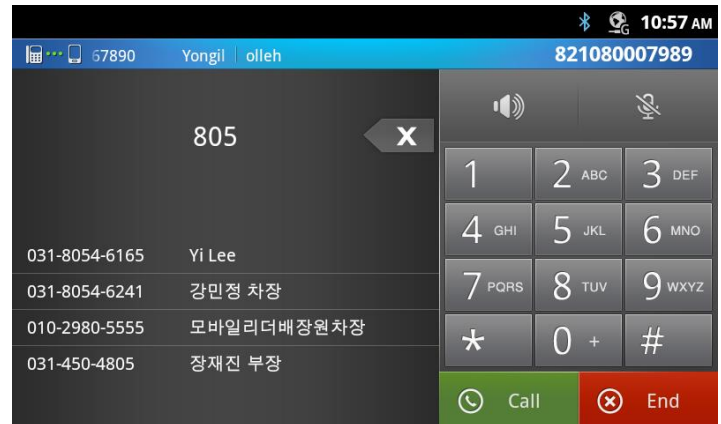

### 11.2.3 Audio Transfer

While active on a Bluetooth HF call, the external Bluetooth device can request to terminate the HF connection and return audio to the device's audio interface. If accepted, the audio is transferred back to the device.

The LIP-9070 can initiate the audio transfer using the Audio Transfer button. The phone will initiate the transfer automatically if an iPECS call is received and audio priority is not assigned for the Bluetooth connection.

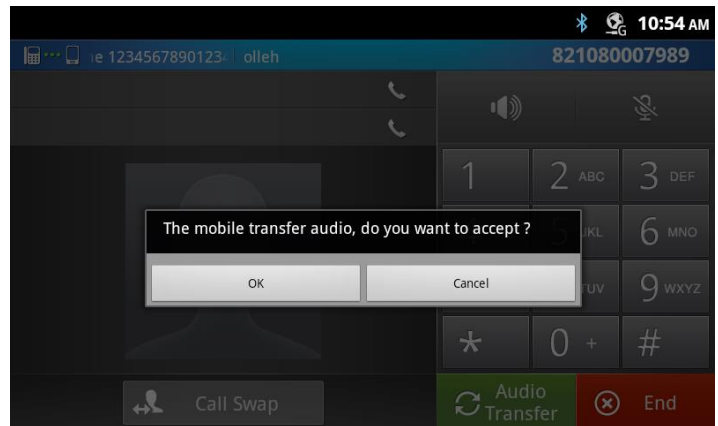

### 11.2.4 Bluetooth HF Audio Priority

Normally, when an iPECS call arrives with the HFP application active, the HFP audio is transferred to the Bluetooth AG, the HFP application closed and the iPECS window opens to notify the user of the new iPECS call. If desired, Bluetooth Handsfree Audio Priority can be set to maintain the Bluetooth call and reject the incoming iPECS call. To enable Bluetooth audio priority,

1. Activate the HFP app by touching the icon in the Apps Dock or on a Launcher screen.
2. Touch the Menu button.
3. Select 'Bluetooth Handsfree Setting' from the Option menu.
4. Touch 'Bluetooth Handsfree audio priority' to check the box and enable Bluetooth priority.

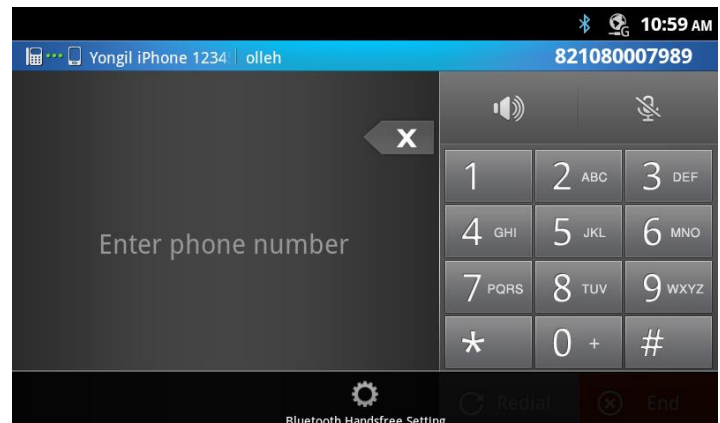

## 12 Settings

The System Settings menu, which accessed with the Setting icon in the Dock or the Home screen option menu, contains a list of items that have a global effect on operation of the LIP-9070. In general, your administrator should configure the Settings. The listing includes:

- *Networks and Bluetooth*: Section 12.1, assign characteristics of the LAN and the Bluetooth interface.
- *Sound*: adjust audio levels, Section 12.2, assign incoming call ringtone and ringtone for Notifications.
- *Display*: Section 12.3, adjust display brightness, enable animations and configure the screen time-out.
- *Applications*: Section 12.4, manage and control applications, and view storage use.
- *Privacy*: Section 12.5, return the LIP-9070 to factory default and erase contacts and all user data from memory.
- *Storage*: Section 12.6, view storage of built-in memory and external SD card, manage SD card and unmounts the SD card.
- *Language & Keyboard*: Section 12.7, select language, select keyboard type and configure Asian keyboards.
- *NTP Settings*: Section 12.8, configure Network Time Protocol server.
- *About phone*: Section 12.9, phone version display and update software.

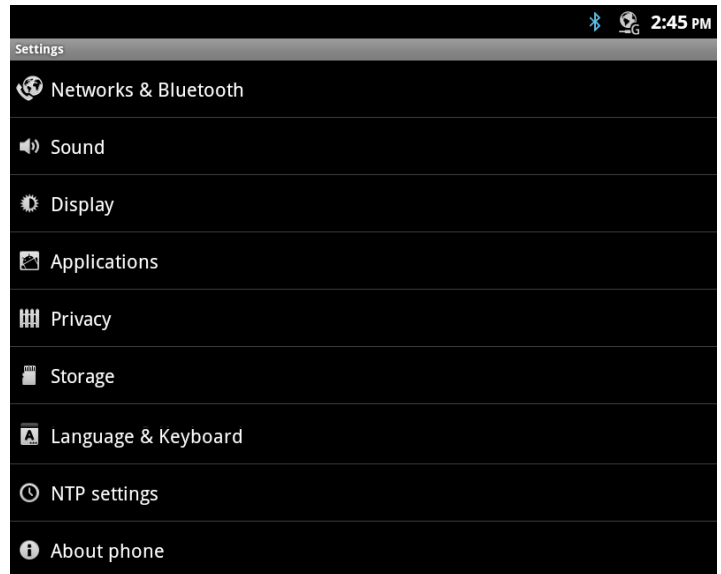

### Note

- You may need to scroll down the screen to see all selections.

### 12.1 Network and Bluetooth

The Network and Bluetooth selection from the settings menu include:

- *Ethernet Settings*: configure the LIP-9070 Ethernet ports for the LAN and an attached PC.
- *Bluetooth*: enable the Bluetooth interface.
- *Bluetooth Settings*: configure the interface, scan for devices and select devices for pairing.

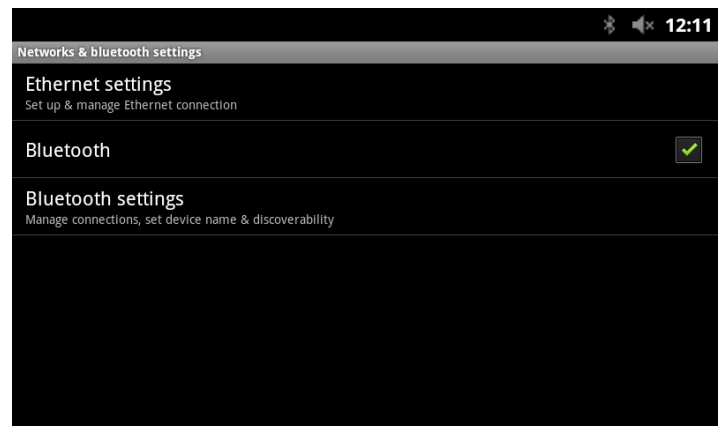

### 12.1.1 Network (Ethernet) Configuration

The Ethernet settings permit configuration of the LIP-9070 network interface and the local PC connection. Configurable characteristics include:

- *IP Address Setting*: select the type of addressing (Static or Dynamic), for Static addressing, configure the IP address, subnet and default Gateway address, also assign DNS server address.
- *OpenVPN Setting*: configure the Open source VPN.
- *VLAN Setting*: configure Virtual LAN id, and priority for LIP-9070 LAN and PC ports.
- *LLDP Setting*: enable Link Layer Discovery Protocol and Automatic VLAN configuration, the later requires LLDP be enabled.
- *802.1x Setting*: assign the Id and password for 802.1x authentications.



#### Note

- On the right side of the Notifications bar an icon, as below, displays showing the settings that are enabled and active. If enabled but not active, the icon is colored grey.



#### 12.1.1.1 OpenVPN

OpenVPN implements virtual private network technology employing an open source software application. The LIP-9070 OpenVPN implements User name/password or certificates for authentication utilizing SSL/TLS (Secure Socket Layer/Transport Layer Security). The following Open VPN characteristics are available.

- *Enable/Disable*: set the Open VPN status.
- *Remote Server*: Open VPN server IP address or URL.
- *Remote port*: set transport protocol port.
- *Protocol Type*: set the transport protocol UDP or TCP.
- *Cipher*: establish any encryption.
- *Compression*: enable or disable compression.
- *ID*: assign authentication User Id.
- *Password*: assign the password for authentication.
- *Install Root CA Certificate*: initiate process to install a CA certificate.

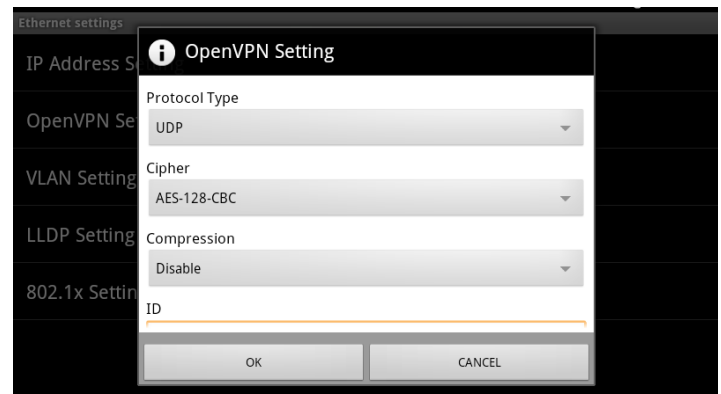
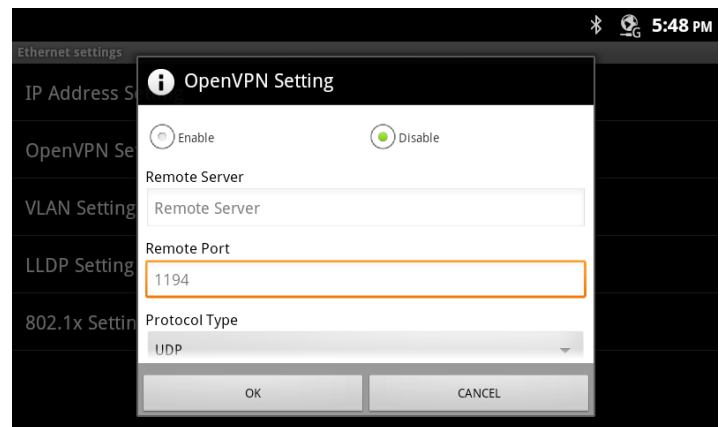

### 12.1.1.2 LLDP Setting

When enabled, the LIP-9070 employs LLDP (Link Layer Discovery Protocol) to advertise capabilities and determine characteristics of the surrounding network environment. The phone can determine and automatically configure VLAN settings for both the LAN and PC ports when LLDP is enabled.

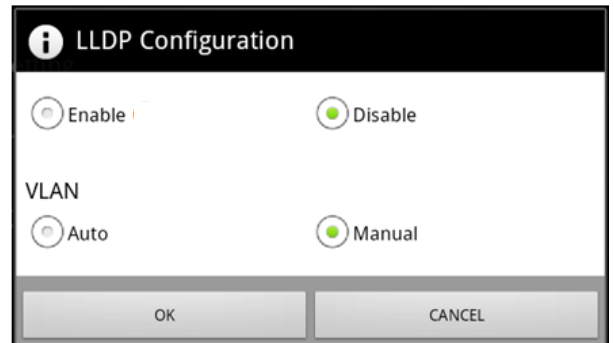

### 12.1.1.3 802.1x Setting

The LIP-9070 supports Layer 2 (Ethernet) security employing 802.1x port based Network Access Control. EAP-MD5 method is used for ID and password authentication for access to the network. The ID and password can be up to 128 characters each.



## 12.1.2 Bluetooth settings

Settings for the Bluetooth interface are:

- *Bluetooth*: checkbox to enable the Bluetooth interface.
- *Device Name*: enter a name that is advertised to other devices.
- *Discoverable*: check to allow other Bluetooth devices to detect the LIP-9070, the interface advertises for 600 seconds.
- *Bluetooth voice device select*: for a Bluetooth device such as a headset, select operating mode as Headset or Speakerphone, the latter receives signals normally sent to the Speaker (audio and ring), a reboot is required.
- *AutoConnect*: external Bluetooth devices can automatically connect with the LIP-9070, if enabled, or select devices from the scan list.
- *Bluetooth Storage select*: define location of storage for files from the Bluetooth device either internal memory or SD card, if available.
- *Scan for devices*: scan and list local Bluetooth devices, and show status and type icon, click to connect manually.

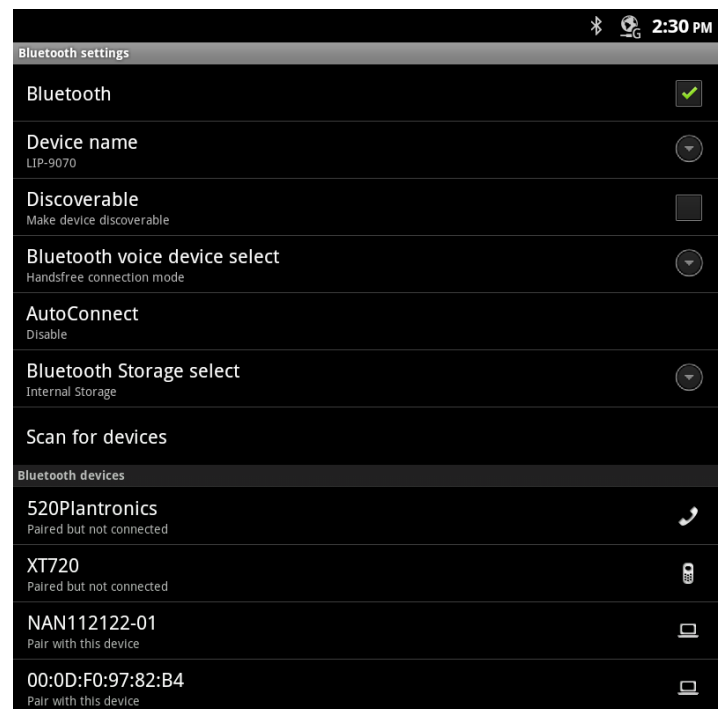

**Note**

- You may need to scroll down the screen to see all selections.
- If the Bluetooth voice or storage device selection is changed, the LIP-9070 must be rebooted. Refer to section 5.5.6 to reboot using the Call Settings, or unplug the phone from power or, if PoE is used to power the phone, unplug the LAN port.

## 12.2 Sound

Sound settings control the ringtones and volume for incoming calls and Notifications. The Sound settings include:

- **Silent Mode:** turn-off the ring signals for incoming calls and most notifications, not alarm clock notifications.
- **Volume:** set the volume level for ringtones, voice and alarm signals.
- **Phone ringtone:** select the tone for incoming intercom calls.
- **Phone External ringtone:** select the tone for incoming calls from a CO line or trunk.
- **Notifications:** select the ringtone for new message and missed call notifications.

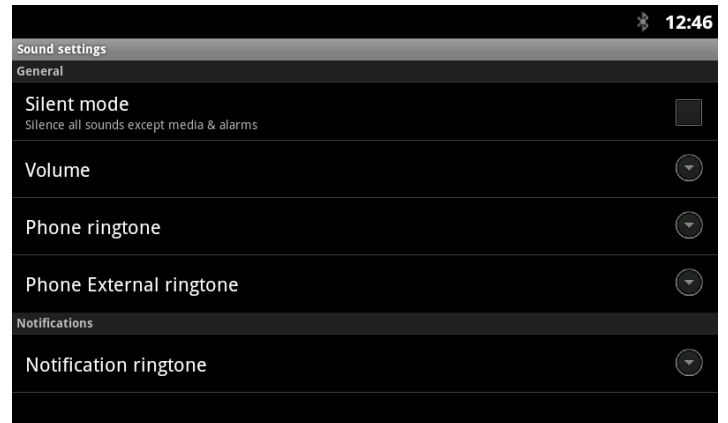

## 12.3 Display

Display settings include:

- **Brightness:** set the screen brightness.
- **Animation:** set screen transition left to right and smooth popup appearance.
- **Screen timeout:** set the duration the screen will stay on when the user takes no action with the LIP-9070.

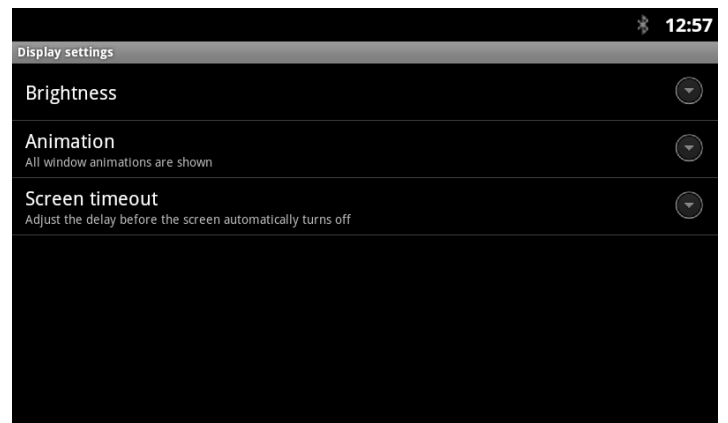

## 12.4 Applications

The Applications settings menu is used to manage and view the status of Android applications in the LIP-9070. Selections include:

- *Unknown sources*: permit installation of applications from sources other than the Android apps store.
- *Manage applications*: manage installed applications.
- *Running services*: manage active process and services.
- *Storage use*: view the storage in use by active applications.

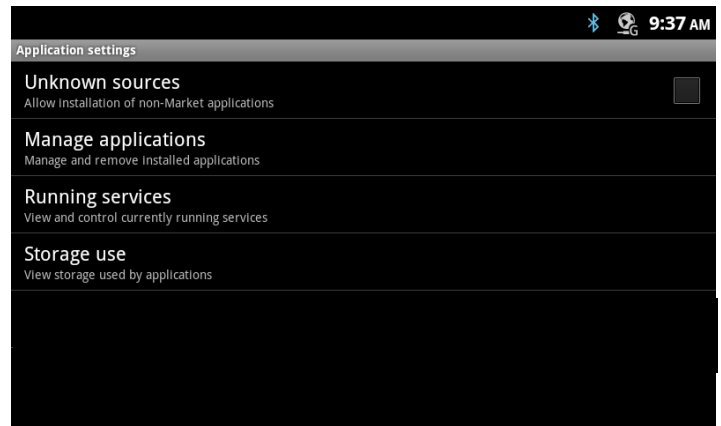

## 12.5 Privacy

Privacy is used to return the LIP-9070 to the default configuration. The reset removes all entries in the Contacts and Calendar databases, and all other personal data stored in the internal Flash memory. Note the reset to default does not impact information stored on the SD card.

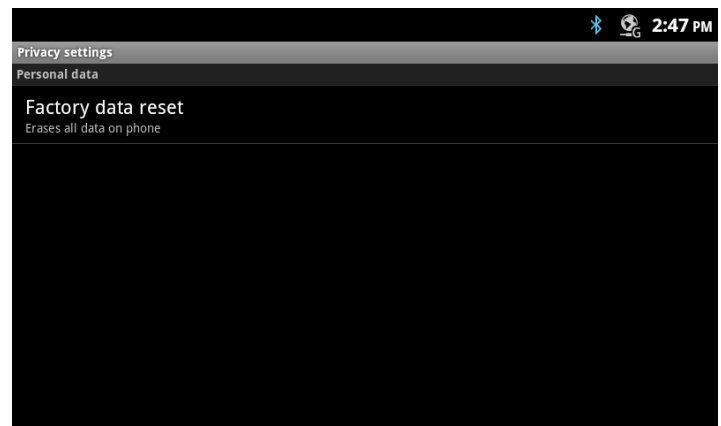

## 12.6 Storage

The Storage settings are provided to view and manage the internal memory and the SD card. Settings include:

- *Internal Storage settings*: view the status of the system memory.
- *SD Card Settings*: Section 12.6.1, view and manage SD card.
- *Available space*: memory space available for user data.

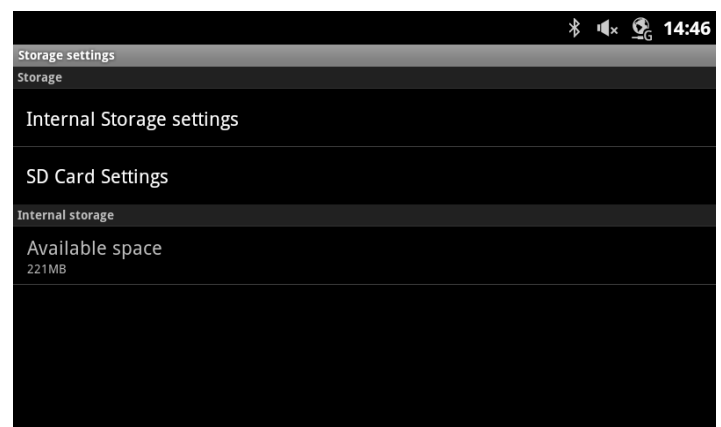

### 12.6.1 SD Card

An SD Card can be inserted in the card slot on the right side of the LIP-9070. With the SD Card Settings, the total and available memory on the card displays, a card can be safely removed with the Unmount command and the data on the card may be erased.

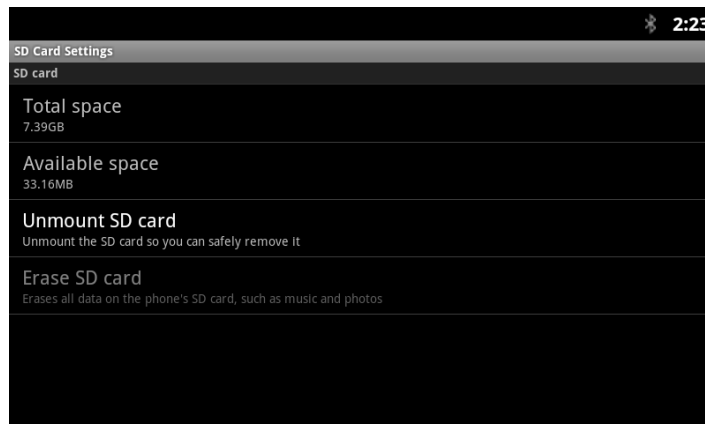

## 12.7 Language & Keyboard

The Language and Keyboard menu includes:

- Select language: select from the available display languages.
- *User dictionary*: selects the dictionary.
- *Android keyboard*: select and configure the standard Android qwerty keyboard.
- *Korean keyboard*: select and configure the Korean keyboard.

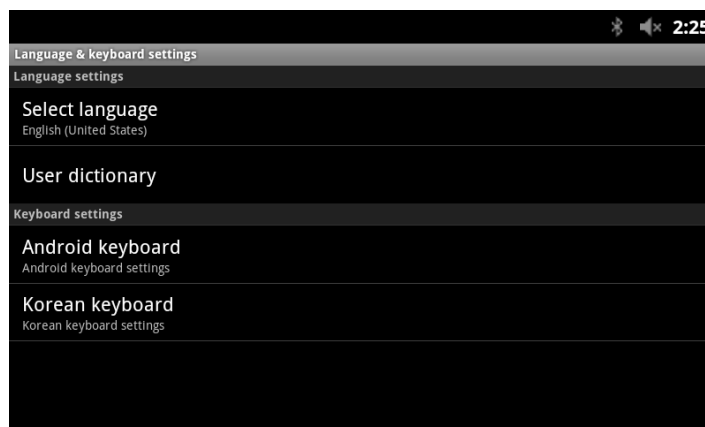

## 12.8 NTP settings

NTP (Network Time Protocol) Server Configuration defines the URL of an NTP server the LIP-9070 will employ to determine the time when verifying VPN certificates.

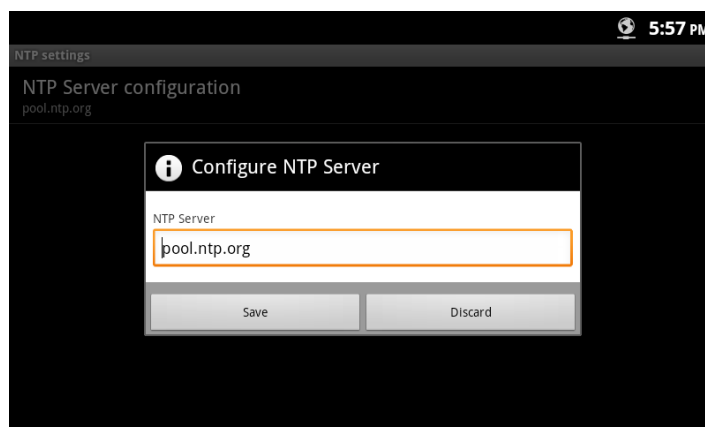



## 12.9 About phone

About displays information about the LIP-9070 including the OS version, build and MAC address. In addition, System Updates can be selected to update the LIP-9070 software from the SD card.

### Note

- You may need to scroll down the screen to see all selections.



### 12.9.1 System Updates

The LIP-9070 software can be updated from the SD card in the slot located on the right side of the phone. When 'System updates' is selected, the LIP-9070 checks for updated software in a valid update.zip file. The file may contain either newer or older version software and, if available on the SD card, a confirmation dialog appears.

Selecting 'Install now' initiates the update process with a phone reboot.

### Note

- During the update procedure, do NOT unplug or remove the phone from the power source.
- An update will return the Call Preferences, Flex button labels and Call Sound settings to the default values.

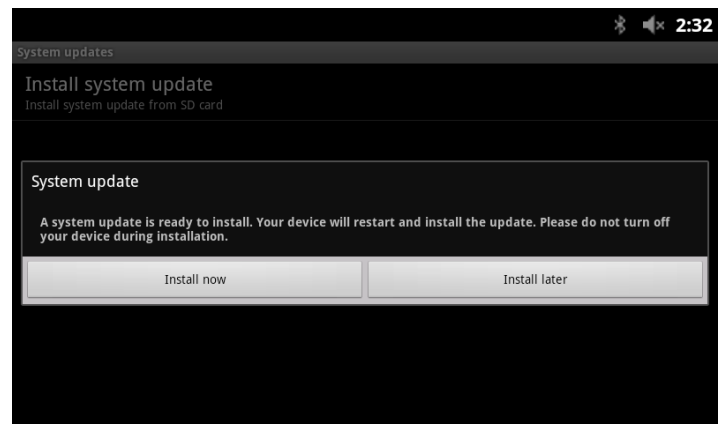

## Appendix A Station User Programming

Like all *iPECS* Phones, the LIP-9070 incorporates the Station User Programming. This programming includes menus and tools that impact the User's station and Flex buttons. Station User Programming is accessed by touching the PGM button (  ) in the *iPECS* Phone application. An item can be selected from the displayed Station User Menu or a Flex button can be selected and assigned a feature.

**Note**

- Station User Programming can be accessed with the Menu button in the *iPECS* Phone screen and then selecting Trans/PGM.

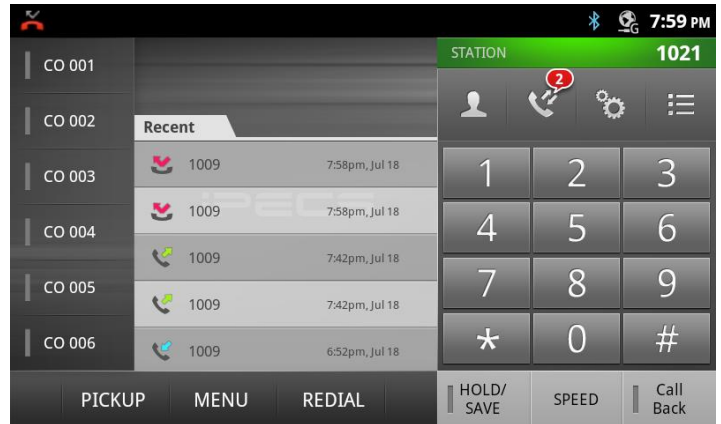

### Station User Menu

The Station User Menu is a layered menu, selecting a menu item exposes the next menu layer until a simple selection for the feature is entered. The main layer of the Station User Menu is shown in the chart below with a brief description of the purpose of each item in the menu. Touching a menu item or dialing the digit in front of the item opens the next layer. Select the next item or enter a value for the item and then press the HOLD/SAVE button.

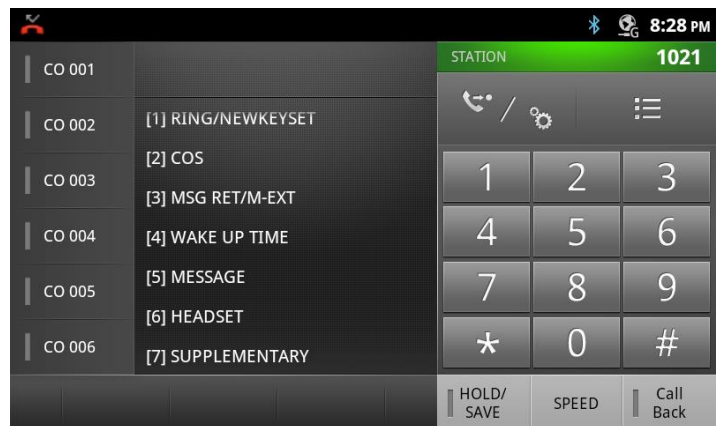

### Station User Menu(iPECS LIK)

Menu Selections	Input and function
<b>[1] RING/NEWKEYSET</b>	
1 Intercom Ring	Select Internal call ringtone, 1 - 8
2 CO Line/Trunk Ring	Select outside call ringtone, 1 - 8
3 Intercom Answer Mode	Select internal call answer mode – 1: HF, 2: Private, 3: Ring
4 Call Coverage Attribute	Allow Coverage (1: On/Off) and select ring delay 2: 0-9
5 Station Ring download	Download ringtones 5 – 8 from <i>iPECS</i>
9 Ear & Mic Headset	Activate Ear/Mic Headset, 1: On, 2: Off
0 Enblock dialing	Set Enblock dialing, all digits are sent to the network at one time
<b>[2] COS</b>	

Menu Selections	Input and function
1 Knock down COS	Set COS to 7, ICM calls only
2 Restore COS	Restore COS, requires password
3 Walking COS	Employ user COS, requires password
<b>[3] MSG RET/M-EXT</b>	
1 View station Callback msgs	Display Station Callback Messages waiting
2 View Missed calls	View missed calls
3 Authorization code	Enter up to 12 digits, Station number + Auth code = password
4 DID Call Wait Button	Assign a button to receive 2 <sup>nd</sup> external DID or DISA call
5 Exec/Sec Pair Msg option	Set Exec or Sec to receive Exec Msg waiting signal
6 Send SMS	Send an SMS, enter receiver and message
7 Register a Mobile extension	Assigns the Mobile phone number to support the Mobile Ext feature
8 Activate Mobile Ext feature	Activate the Mobile Ext feature, calls ring the Mobile and desk phone
9 Set Mobile CLI	Assign the Mobile CLI to support the Mobile Calling feature
0 Notify Mobile for new VM	When a new Voice mail is received, notify the registered Mobile phone
<b>[4] WAKE UP TIME</b>	
1 Set Wake up time	Select Alarm 1-5, enter time and repeat
2 Erase Wake up time	Select Alarm 1-5 and erase
<b>[5] MESSAGE</b>	
1 Activate Display Message	Display a Custom or Pre-defined Msg, select Msg 00 - 20
2 Input a Custom Message	Msg 00, enter up to 24 characters, two digits/character
3 Create a Conf room	Activate a Conference Room (1-9) and assign password
4 Delete a Conf room	Delete a Conference Room
5 Monitor a Conf Group	Monitor a personal Conference group status
<b>[6] HEADSET</b>	
1 Headset or Spkrphone	Audio through headset or Spkrphone, 1: HS, 2: Spkrphone
2 Headset ring mode	1: ring Spkrphone, 2: ring Headset, 3: Both
<b>[7] SUPPLEMENTARY</b>	
1 LCD Change Language	Toggles through the available display languages
2 Version Display	Display the phone software version
3 Background Music	Select and play BGM from the <b>IPECS</b>
4 Enter Station Name Reg.	Station Display number sent to other users, 7-characters
5 Display IP Address	Displays the phone's IP address
6 Change IP Address	Change the IP address, only if Static mode

Menu Selections	Input and function
7 Display MAC Address	Displays the Phone's MAC address
8 Change Connect Mode	Set the <i>iPECS</i> connection mode, 1: Local, 2: Remote, 3: Local/Remote
9 Display Phone Version	View the software version of the phone
<b>* SYSTEM</b>	
6 Set Forced Fwd Dest	Assign a destination for Forced Forward
7 Forced Fwd to Dest	Activate Forced Forward
8 Register Bluetooth	Enter a Bluetooth device for use
9 Bluetooth Usage	Pair and Connect a Bluetooth device
0 Hot desk Login	Log in to a Hot desk station
* Hot desk Logout	Log out of a Hot desk station
# Enter Admin	Access the Keypad Admin, a password may be required

\*\* Button assignment menus 8 and 9 do not display in the Station User Menu and are used only to assign a function to a Flex button.

## Configuring Flex Buttons

Access to the Station User Menu also permits the user to reconfigure the Flex buttons on the phone. Buttons can be configured to call and monitor the status of another station, select an item from the Station User Menu or dial a number from the *iPECS* Numbering Plan . In addition to the Station User Menu codes, certain additional button Function codes may be available for Flex button assignment as shown in the Station User Codes chart in Appendix section A.1. Not all Station User Menu codes can be assigned to a Flex button of all phones.

To configure a Flex button,

1. Touch the PGM button (  ).
2. Press the desired Flex button, the present function of the button displays.
3. Dial a Station Number,  
Dial a number from the *iPECS* Numbering plan or  
Press the PGM button and dial a Station User Menu code.
4. Press the Hold/Save button to store the new configuration.
5. Repeat steps 2 to 4 for additional button programming.

### Note

- To use a button may require configuration of the *iPECS* to enable use of the feature by the station.
- The user may not be allowed to assign or modify buttons for outside access such as a CO Line button, a Loop button, etc.

## Appendix B Web Admin

The LIP-9070 software incorporates a Web server used to configure the LIP-9070 IP addressing, *iPECS* host parameters, Network setting characteristics, flexible buttons, etc. The Web Manager allows for remote access to the LIP-9070 through the LAN port and is intended for use by the *iPECS* administrator.

### Web Manager Login

To access the Web Manager, point the browser to the IP address of the LIP-9070 at TCP port 8000 as `<ip address:8000>`. The Web Manager may be password protected. At the Login screen enter the password and touch the Authenticate button. There is no default password.

### LIP-9070 Web Manager

**This unit is password protected**

Please enter the correct password to access web page

### Overview Screen

At login, the Overview screen displays a list of menus on the left and general information for the LIP-9070. Touching the menu item in the left navigation exposes the menu where data can be entered and saved.

## LIP-9070 Administration

<ul style="list-style-type: none"> <li>Overview</li> <li>Security</li> <li>LAN Setting</li> <li>VLAN Setting</li> <li>System Setting</li> <li>DiffServ</li> <li>DiffServ (Video)</li> <li>Device Number</li> <li>Flexible Button (Group 1)</li> <li>Flexible Button (Group 2)</li> <li>Flexible Button (Group 3)</li> <li>Flexible Button (Group 4)</li> </ul>	<div style="text-align: center;">  <h3>SYSTEM INFORMATION</h3> </div> <table style="width: 100%; border-top: 1px solid #ccc; border-bottom: 1px solid #ccc;"> <tr><td>Model:</td><td>LIP-9070</td></tr> <tr><td>SW Version:</td><td>1.0.144</td></tr> <tr><td>HW Version:</td><td>0.0.1</td></tr> <tr><td>Bootrom Version:</td><td>1.1.6</td></tr> <tr><td>Kernel Version:</td><td>2.6.35.7-tcc (package@mmt-OEM) #152</td></tr> <tr><td>System Uptime:</td><td>Tue Jul 10 17:08:54 KST 2012</td></tr> <tr><td>LAN IP Address:</td><td>124.46.127.188</td></tr> <tr><td>MAC Address:</td><td>00:40:5a:2e:49:10</td></tr> <tr><td>Security:</td><td>Password Installed</td></tr> </table>	Model:	LIP-9070	SW Version:	1.0.144	HW Version:	0.0.1	Bootrom Version:	1.1.6	Kernel Version:	2.6.35.7-tcc (package@mmt-OEM) #152	System Uptime:	Tue Jul 10 17:08:54 KST 2012	LAN IP Address:	124.46.127.188	MAC Address:	00:40:5a:2e:49:10	Security:	Password Installed
Model:	LIP-9070																		
SW Version:	1.0.144																		
HW Version:	0.0.1																		
Bootrom Version:	1.1.6																		
Kernel Version:	2.6.35.7-tcc (package@mmt-OEM) #152																		
System Uptime:	Tue Jul 10 17:08:54 KST 2012																		
LAN IP Address:	124.46.127.188																		
MAC Address:	00:40:5a:2e:49:10																		
Security:	Password Installed																		

## Security Menu

The Security menu permits the definition of a password of up to 20 characters. When entered, the password will be required in the LIP-9070 Web Manager login screen.

### LIP-9070 Administration

- Overview
- Security**
- LAN Setting
- VLAN Setting
- System Setting
- DiffServ
- DiffServ (Video)
- Device Number

#### SET SECURITY PASSWORD

New password	
Confirm new password	

## LAN Settings

The LAN Setting menu configures the address Mode, Static or Dynamic. If static addressing is employed, the IP and Gateway address as well as the subnet mask must be defined. In addition a Primary and secondary DNS (Directory Name Server) can be configured to support VPN installations.

### LIP-9070 Administration

- Overview
- Security
- LAN Setting**
- VLAN Setting
- System Setting
- DiffServ
- DiffServ (Video)
- Device Number
- Flexible Button (Group 1)
- Flexible Button (Group 2)
- Flexible Button (Group 3)

#### LAN Configuration

IP Address Mode	<input checked="" type="radio"/> Static <input type="radio"/> DHCP
IP Address	124.46.127.188
Gateway Address	124.46.127.254
Subnet mask	255.255.255.0
Primary DNS	61.41.106.223
Secondary DNS	0.0.0.0

## VLAN Settings

The VLAN Setting menu configures the Id and password of Virtual LANs for both the LAN and PC port. Enable the VLAN Status, enter a priority and id for both the LAN and PC port and save the changes.

The PC port should have a lower priority than the terminal; typically a PC priority of 3 and Terminal priority of 5 provide acceptable performance. Also, in general, the PC VLAN id will be 0, while the Terminal VLAN id will be a number between 1 and 4094.

LIP-9070 Administration

- Overview
- Language
- Security
- LAN Setting
- VLAN Setting**
- System Setting
- DiffServ
- DiffServ (Video)
- Device Number
- Flexible Button (Group 1)
- Flexible Button (Group 2)
- Flexible Button (Group 3)

### VLAN Configuration

Status	<input checked="" type="radio"/> Disable <input type="radio"/> Enable
PC Priority	3
Terminal Priority	5
PC VLAN(0~4094)	0
Terminal VLAN (0~4094)	0

## System Setting

The System Setting assigns the IP address of the **iPECS** system and the type of connection that can be local, remote or Local/remote. If these values are changed, the phone must restart to properly register with the **iPECS** system.

LIP-9070 Administration

- Overview
- Security
- LAN Setting
- VLAN Setting
- System Setting**
- DiffServ
- DiffServ (Video)
- Device Number
- Flexible Button (Group 1)
- Flexible Button (Group 2)

### System Configuration

**MFIM Settings**

MFIM Settings	10.10.10.2
Connection Mode	Local

## DiffServ Menu

DiffServ also called Differential Services is a protocol allowing routers to provide differing levels of service based on the DiffServ Code Point (DSCP). Diffserv is a commonly supported layer-3 protocol that, to be effective, must be support by all routers in the chain. The higher the DSCP the sooner the router will send the packet. However, in a congested environment, packets with the highest DSCP are discarded first.

This menu establishes the DSCP the LIP-9070 will employ with voice and signaling packets.

In the menu, enable or disable Diffserv, select an appropriate Code Point and save the changes.

### LIP-9070 Administration

- Overview
- Security
- LAN Setting
- VLAN Setting
- System Setting
- DiffServ
- DiffServ (Video)
- Device Number
- Flexible Button (Group 1)
- Flexible Button (Group 2)
- Flexible Button (Group 3)
- Flexible Button (Group 4)
- Flexible Button (Group 5)
- Video Frame Rate
- Firmware Upgrade Configuration
- Execute Firmware Update
- Open VPN
- LLDP
- 802.1x
- Time Setting

#### LAN DiffServ Codepoint Configuration (Voice&Signal)

Enable DiffServ  Disable  Enable

Default Expected (DE)  
Codepoint: 000000

Assured Forwarding (AF)

	Class 1	Class 2	Class 3	Class 4
Low Drop Prec	<input checked="" type="radio"/> 001010	<input type="radio"/> 010010	<input type="radio"/> 011010	<input type="radio"/> 100010
Med Drop Prec	<input type="radio"/> 001100	<input type="radio"/> 010100	<input type="radio"/> 011100	<input type="radio"/> 100100
High Drop Prec	<input type="radio"/> 001110	<input type="radio"/> 010110	<input type="radio"/> 011110	<input type="radio"/> 100110

Expedited Forwarding (EF)  
Codepoint: 101110

User Defined (UD)  
Codepoint:

## Video DiffServ Menu

The Diffserv (Video) menu establishes the DSCP applied to video packets only. Refer to section A.6 for a brief discussion of Diffserv.

### LIP-9070 Administration

- Overview
- Security
- LAN Setting
- VLAN Setting
- System Setting
- DiffServ
- DiffServ (Video)
- Device Number
- Flexible Button (Group 1)
- Flexible Button (Group 2)
- Flexible Button (Group 3)
- Flexible Button (Group 4)
- Flexible Button (Group 5)
- Video Frame Rate
- Firmware Upgrade Configuration
- Execute Firmware Update
- Open VPN
- LLDP
- 802.1x
- Time Setting

#### DiffServ Codepoint Configuration (Video)

Enable DiffServ  Disable  Enable

Default Expected (DE)  
Codepoint: 000000

Assured Forwarding (AF)

	Class 1	Class 2	Class 3	Class 4
Low Drop Prec	<input checked="" type="radio"/> 001010	<input type="radio"/> 010010	<input type="radio"/> 011010	<input type="radio"/> 100010
Med Drop Prec	<input type="radio"/> 001100	<input type="radio"/> 010100	<input type="radio"/> 011100	<input type="radio"/> 100100
High Drop Prec	<input type="radio"/> 001110	<input type="radio"/> 010110	<input type="radio"/> 011110	<input type="radio"/> 100110

Expedited Forwarding (EF)  
Codepoint: 101110

User Defined (UD)  
Codepoint:



## Desired Station Number

A desired station number can be configured in the Device Number menu. At registration the phone will request the station number desired. If available, the **iPECS** allows use of the desired number.

The screenshot shows the 'LIP-9070 Administration' interface. On the left is a navigation menu with the following items: Overview, Security, LAN Setting, VLAN Setting, System Setting, DiffServ, DiffServ (Video), and Device Number. The 'Device Number' menu item is highlighted. The main content area is titled 'Device Number' and contains a 'Station Number' input field with a text box and a 'Save Device Number' button.

## Flexible Buttons

The LIP-9070 has a group of thirty (30) Flexible or Flex buttons. The function for each button is configured in the **iPECS** or through the Station User Programming. For more on Flex button assignments see the host **iPECS** manuals.

The Flex button menu defines a label for the button of up to 16 characters. The Flex buttons are assigned in 5 different menus with 6 buttons per menu. Here, the Flex button Group 1 menu is shown covering buttons 1 ~ 6. The remaining four (4) Flex button menus are identical except for the Flex button numbers match the Flex button group selected.

Enter a custom label for each of the displayed Flex buttons and save the changes. If no custom label is assigned, a default label based on the button function or blank for unassigned buttons is used.

The screenshot shows the 'LIP-9070 Administration' interface. On the left is a navigation menu with the following items: Overview, Security, LAN Setting, VLAN Setting, System Setting, DiffServ, DiffServ (Video), Device Number, Flexible Button (Group 1), Flexible Button (Group 2), Flexible Button (Group 3), Flexible Button (Group 4), Flexible Button (Group 5), and Video Frame Data. The 'Flexible Button (Group 1)' menu item is highlighted. The main content area is titled 'Flexible Button Configuration' and contains a table titled 'Flexible Button Settings' with 6 rows and 2 columns. The first column lists 'Flexible Button 1' through 'Flexible Button 6', and the second column contains input fields with the values 'CO 001' through 'CO 006'. Below the table is a 'Save Flexible Button' button.

Flexible Button Settings	
Flexible Button 1	CO 001
Flexible Button 2	CO 002
Flexible Button 3	CO 003
Flexible Button 4	CO 004
Flexible Button 5	CO 005
Flexible Button 6	CO 006

## Firmware Upgrade

From time to time the LIP-9070 phone software may be modified or upgraded to improve performance or add features. The LIP-9070 software can be upgraded to the modified software. The upgrade may include updates to the Android operating system as well as the **iPECS** Phone application. The upgrade software file named *update.zip*, is placed on an http/https server. The software is then downloaded by the phone. The phone reboots and loads the new software. Note that the upgrade software on the server may be a previous or newer version than is running on the LIP-9070.

**Note**

- The upgrade software file, *upgrade.zip*, can be obtained from the local Ericsson-LG representative.
- During the upgrade procedure, do NOT unplug or remove the phone from the power source or LAN.
- An upgrade will return the Call Preferences, Flex button labels and Call Sound settings to the default values.

## Firmware Upgrade Configuration

Prior to upgrading the software, the phone must be configured with the upgrade server information. The information required includes the server IP address or URL and for https, the Authentication ID and password. The phone may request the server IP address or URL from the local DHCP server using Option 160 as the server address or URL.

**Note**

- *iPECS-CM* may use FTP to upgrade the phone software.

## Execute Firmware Upgrade

Once the software is loaded on the upgrade server and the phone configured with the server information, the software can be upgraded. To upgrade the software,

1. Select 'Execute Firmware Upgrade'.
2. The LIP-9070 contacts the upgrade server and downloads the firmware.

**LIP-9070 Administration**

[Overview](#)

[Security](#)

[LAN Setting](#)

[VLAN Setting](#)

[System Setting](#)

[DiffServ](#)

[DiffServ \(Video\)](#)

[Device Number](#)

[Flexible Button \(Group 1\)](#)

[Flexible Button \(Group 2\)](#)

[Flexible Button \(Group 3\)](#)

[Flexible Button \(Group 4\)](#)

[Flexible Button \(Group 5\)](#)

[Video Frame Rate](#)

[Firmware Upgrade Configuration](#)

[Execute Firmware Update](#)

### Firmware Upgrade Configuration

	HTTP/HTTPS	<input type="text" value="http://150.150.140.105/"/>	
HTTP/HTTPS	URL	<input checked="" type="checkbox"/> Received by DHCP	Option <input type="text" value="160"/>
	ID	<input type="text"/>	
	Password	<input type="text"/>	

**LIP-9070 Administration**

[Overview](#)

[Security](#)

[LAN Setting](#)

[VLAN Setting](#)

[System Setting](#)

[DiffServ](#)

[DiffServ \(Video\)](#)

[Device Number](#)

[Flexible Button \(Group 1\)](#)

[Flexible Button \(Group 2\)](#)

[Flexible Button \(Group 3\)](#)

[Flexible Button \(Group 4\)](#)

[Flexible Button \(Group 5\)](#)

[Video Frame Rate](#)

[Firmware Upgrade Configuration](#)

[Execute Firmware Update](#)

[Open VPN](#)

### Execute firmware

Please click to Execute button to update firmware

## Open VPN

OpenVPN implements virtual private network technology employing an open source software application. The LIP-9070 OpenVPN implements User name/password or certificates for authentication utilizing SSL/TLS (Secure Socket Layer/Transport Layer Security).

Among the needed parameters, once the Status is enabled, the remote server must be identified and the authentication parameters, ID, and Password or certificate must be defined.

**LIP-9070 Administration**

<ul style="list-style-type: none"> <li><a href="#">Overview</a></li> <li><a href="#">Security</a></li> <li><a href="#">LAN Setting</a></li> <li><a href="#">VLAN Setting</a></li> <li><a href="#">System Setting</a></li> <li><a href="#">DiffServ</a></li> <li><a href="#">DiffServ (Video)</a></li> <li><a href="#">Device Number</a></li> <li><a href="#">Flexible Button (Group 1)</a></li> <li><a href="#">Flexible Button (Group 2)</a></li> <li><a href="#">Flexible Button (Group 3)</a></li> <li><a href="#">Flexible Button (Group 4)</a></li> <li><a href="#">Flexible Button (Group 5)</a></li> <li><a href="#">Video Frame Rate</a></li> <li><a href="#">Firmware Upgrade Configuration</a></li> <li><a href="#">Execute Firmware Update</a></li> <li><a href="#">Open VPN</a></li> </ul>	<div style="background-color: #0070C0; color: white; padding: 5px;"> <b>Network &amp; Security: OpenVPN</b> </div> <table border="1" style="width: 100%; border-collapse: collapse;"> <tr> <td style="width: 50%;">Status</td> <td style="width: 50%;"> <input checked="" type="radio"/> Disable                     <input type="radio"/> Enable                 </td> </tr> <tr> <td>Remote Server Address</td> <td><input type="text"/></td> </tr> <tr> <td>Remote Server Port</td> <td>1194</td> </tr> <tr> <td>Protocol Type</td> <td> <input checked="" type="radio"/> UDP                     <input type="radio"/> TCP                 </td> </tr> <tr> <td>Cipher</td> <td>AES128-CBC</td> </tr> <tr> <td>Compression</td> <td> <input checked="" type="radio"/> Disable                     <input type="radio"/> Enable                 </td> </tr> <tr> <td>ID(Username for VPN)</td> <td><input type="text"/></td> </tr> <tr> <td>Password</td> <td><input type="text"/></td> </tr> <tr> <td colspan="2" style="text-align: center;">Root CA Certificate is installed</td> </tr> <tr> <td colspan="2" style="text-align: right;"> <input type="button" value="Browse..."/> </td> </tr> </table> <p style="text-align: center;"><input type="button" value="Submit"/></p>	Status	<input checked="" type="radio"/> Disable <input type="radio"/> Enable	Remote Server Address	<input type="text"/>	Remote Server Port	1194	Protocol Type	<input checked="" type="radio"/> UDP <input type="radio"/> TCP	Cipher	AES128-CBC	Compression	<input checked="" type="radio"/> Disable <input type="radio"/> Enable	ID(Username for VPN)	<input type="text"/>	Password	<input type="text"/>	Root CA Certificate is installed		<input type="button" value="Browse..."/>	
Status	<input checked="" type="radio"/> Disable <input type="radio"/> Enable																				
Remote Server Address	<input type="text"/>																				
Remote Server Port	1194																				
Protocol Type	<input checked="" type="radio"/> UDP <input type="radio"/> TCP																				
Cipher	AES128-CBC																				
Compression	<input checked="" type="radio"/> Disable <input type="radio"/> Enable																				
ID(Username for VPN)	<input type="text"/>																				
Password	<input type="text"/>																				
Root CA Certificate is installed																					
<input type="button" value="Browse..."/>																					

## LLDP

When enabled, the LIP-9070 employs LLDP (Link Layer Discovery Protocol) to advertise capabilities and determine characteristics of the surrounding network environment. The phone can determine and automatically configure VLAN settings for both the LAN and PC ports when LLDP is enabled.

**LIP-9070 Administration**

<ul style="list-style-type: none"> <li><a href="#">Overview</a></li> <li><a href="#">Security</a></li> <li><a href="#">LAN Setting</a></li> <li><a href="#">VLAN Setting</a></li> <li><a href="#">System Setting</a></li> <li><a href="#">DiffServ</a></li> <li><a href="#">DiffServ (Video)</a></li> <li><a href="#">Device Number</a></li> <li><a href="#">Flexible Button (Group 1)</a></li> <li><a href="#">Flexible Button (Group 2)</a></li> <li><a href="#">Flexible Button (Group 3)</a></li> <li><a href="#">Flexible Button (Group 4)</a></li> <li><a href="#">Flexible Button (Group 5)</a></li> <li><a href="#">Video Frame Rate</a></li> <li><a href="#">Firmware Upgrade Configuration</a></li> <li><a href="#">Execute Firmware Update</a></li> <li><a href="#">Open VPN</a></li> <li><a href="#">LLDP</a></li> </ul>	<div style="background-color: #0070C0; color: white; padding: 5px;"> <b>Network &amp; Security: LLDP</b> </div> <table border="1" style="width: 100%; border-collapse: collapse;"> <tr> <td style="width: 50%;">Status</td> <td style="width: 50%;"> <input checked="" type="radio"/> Disable                     <input type="radio"/> Enable                 </td> </tr> <tr> <td>VLAN</td> <td> <input checked="" type="radio"/> Auto                     <input type="radio"/> Manual                 </td> </tr> </table> <p style="text-align: center;"><input type="button" value="Submit"/></p>	Status	<input checked="" type="radio"/> Disable <input type="radio"/> Enable	VLAN	<input checked="" type="radio"/> Auto <input type="radio"/> Manual
Status	<input checked="" type="radio"/> Disable <input type="radio"/> Enable				
VLAN	<input checked="" type="radio"/> Auto <input type="radio"/> Manual				

### 802.1x

The LIP-9070 supports Layer 2 (Ethernet) security employing 802.1x port based Network Access Control. EAP-MD5 method is used for ID and password authentication for access to the network.

The Id and password can be a maximum of 128 characters.

LIP-9070 Administration

[Firmware Upgrade Configuration](#)

[Execute Firmware Update](#)

[Open VPN](#)

[LLDP](#)

[802.1x](#)

[Time Setting](#)

[Reboot](#)

#### Network & Security: 802.1x

Status	<input checked="" type="radio"/> Disable <input type="radio"/> Enable
ID	<input style="width: 90%;" type="text"/>
Password	<input style="width: 90%;" type="password"/>

### Time Server

NTP (Network Time Protocol) Server Configuration defines the URL of an NTP sever the LIP-9070 will employ to determine the time when verifying VPN certificates.

LIP-9070 Administration

[Video Frame Rate](#)

[Firmware Upgrade Configuration](#)

[Execute Firmware Update](#)

[Open VPN](#)

[LLDP](#)

[802.1x](#)

[Time Setting](#)

[Reboot](#)

[Logout](#)

#### Time Setting

Network Time Configuration

NTP Server Address	<input style="width: 90%;" type="text" value="pool.ntp.org"/>
--------------------	---

## Reboot

When certain parameters, see list below, are modified, the phone will require a reboot to modify the active configuration.

A reboot will terminate all network connections and registrations with an **iPECS** host. After the reboot the phone will establish the network connection and register with the **iPECS**.

The screenshot displays the LIP-9070 Administration web interface. The main heading is "LIP-9070 Administration". On the left is a navigation menu with the following items: Overview, Language, Security, LAN Setting, VLAN Setting, System Setting, DiffServ, DiffServ (Video), Device Number, Flexible Button (Group 1), Flexible Button (Group 2), Flexible Button (Group 3), Flexible Button (Group 4), Flexible Button (Group 5), Video Frame Rate, Firmware Update Configuration, Execute Firmware Update, Open VPN, LLDP, 802.1x, Time Setting, Reboot, and Logout. The "Reboot" item is highlighted. The main content area is titled "REBOOT" and contains a red warning message: "Caution, a Reboot will terminate the active network connection and system registration." Below this is the instruction "To reboot click the REBOOT button" and a button labeled "REBOOT".

## Appendix C Touch screen calibration

The LIP-9070 uses touch screen as user interface. If user have some problem to the touch screen operation the below sequence could provide to do touch screen calibration manually.

- 1) Move to 'Home' screen.
- 2) Press 'Menu' key twice.
- 3) Press 'Back' key once.
- 4) Press 'Volume down' key seven times.
- 5) Press 'Volume up' key three times.
- 6) Press 'Back' key five times. -\* have to do 3~6<sup>th</sup> within 10 second. \*-
- 7) Then, start the calibration of touch panel and you can find below display.



Thanks